

## FLUID FILLER LOCATIONS

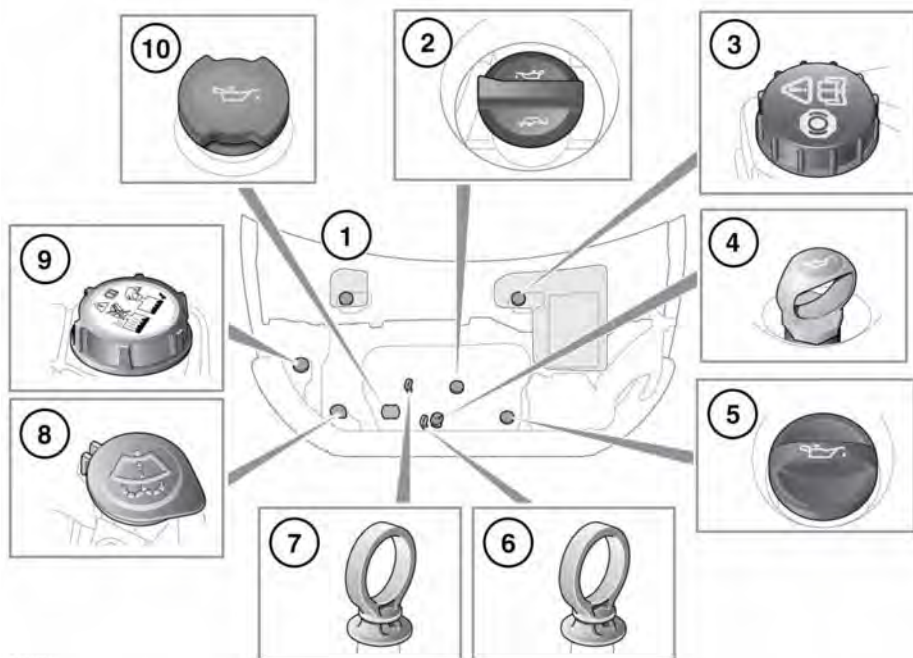

E174071

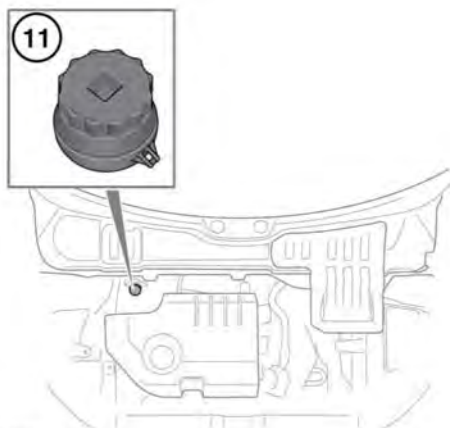



E174070

1. Brake fluid reservoir cap (right-hand drive). Remove the right side under bonnet cover for access. See **201, UNDER BONNET COVERS - REMOVAL**.
2. Engine oil filler cap (2.0L petrol engine).
3. Brake fluid reservoir cap (left-hand drive). Remove the left side under bonnet cover for access. See **201, UNDER BONNET COVERS - REMOVAL**.
4. Oil level dipstick (2.2L diesel engine).
5. Engine oil filler cap (2.2L diesel engine).
6. Oil level dipstick (2.0L diesel engine).



# Fluid level checks

- Oil level dipstick (2.0L petrol engine).
- Washer fluid reservoir filler cap.
- Engine coolant reservoir filler cap.
- Engine oil filler cap (2.0L diesel engine).
- Diesel Exhaust Fluid (DEF) reservoir filler cap. See 189, **DIESEL EXHAUST FLUID (DEF)**.

 While working in the engine compartment, always observe the safety precautions. See 199, **SAFETY IN THE GARAGE**.

 Do not start the engine, or drive the vehicle, if there is a possibility that any leaked fluid will come into contact with a hot surface, such as the exhaust. Seek qualified assistance immediately.

## CHECKING THE ENGINE OIL LEVEL

-  Check the engine oil weekly. If any significant or sudden drop in oil level is noted, seek qualified assistance.
-  Never allow the oil level to fall below the lower mark or notch on the dipstick.
-  If the message **ENGINE OIL PRESSURE LOW** is displayed, stop the engine as soon as it is safe to do so and seek qualified assistance. Do not start the engine until the cause has been rectified.

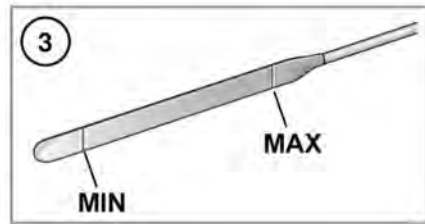
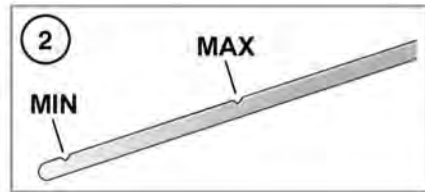
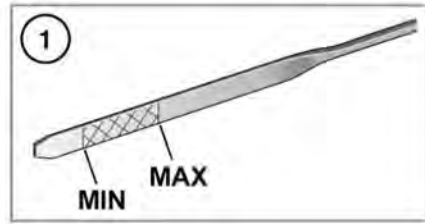

E112019

- Engine oil dipstick - 2.0L petrol.
  - Engine oil dipstick - 2.2L diesel.
  - Engine oil dipstick - 2.0L diesel
-  The dipstick on 2.0L diesel engines features a lug, to aid correct fitment. Make sure the lug is correctly aligned with the groove in the dipstick tube. Failure to do this could result in the dipstick not fitting correctly, and oil escaping from the engine.

Prior to checking the oil level, make sure that:

- The vehicle is on level ground.
- The engine oil is cold.

**Note:** If it is necessary to check the oil level when the engine is hot, switch off the engine and let the vehicle stand for 5 minutes to allow the oil to drain back into the sump. Do not start the engine.

The oil level can then be checked as follows:

1. Withdraw the dipstick and wipe the blade clean with a lint-free cloth.
2. Fully re-insert the dipstick and withdraw again to check the oil level.

As a general guide, if the oil level on the dipstick:

1. Is nearer to the upper mark or notch than the lower, do not add oil.
2. Is nearer to the lower mark or notch than the upper, add 0.5 litres of oil.
3. Is below the lower mark or notch, add:
  - 2.0L petrol engine: 0.8 litres of oil.
  - 2.2L diesel engine: 1.5 litres of oil.
  - 2.0L diesel engine: 1.8 litres of oil.Recheck the level after a further 5 minutes.

## TOPPING UP THE OIL

- ⚠ Your vehicle's warranty may be invalidated if damage is caused by using oil that does not meet the required specification.
- ⚠ Failure to use an oil that meets the required specification could cause excessive engine wear, a build up of sludge and deposits, and increase pollution. It could also lead to engine failure. See **264, LUBRICANTS AND FLUIDS**.

- ⚠ Overfilling with oil could result in severe engine damage. Oil should be added in small quantities and the level rechecked to make sure the engine is not overfilled.

1. Remove the oil filler cap.
2. Add oil to maintain the level between the **MIN** and **MAX** marks or notches on the dipstick.

- ⚠ It is essential to use the correct specification oil and to make sure the oil is suitable for the climatic conditions in which the vehicle is to be operated.

**Note:** The approximate quantity of oil required to raise the level from **MIN** to **MAX** is 0.85 litres on the 2.0L petrol engine; 1.5 litres on the 2.2L diesel engine; and 1.8 litres on the 2.0L diesel engine.

3. Clean up any oil spilled during topping up.
4. Check the oil level again after 5 minutes.
5. Refit the oil filler cap.

## CHECKING THE COOLANT LEVEL

- ⚠ Running the engine without coolant will cause serious engine damage.
- ⚠ If persistent coolant loss is noticed, seek qualified assistance immediately.

The coolant reservoir level should be checked at least weekly (more frequently in high mileage or arduous operating conditions). Always check the level when the system is cold.

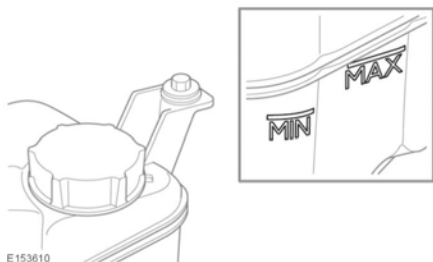

Make sure the coolant level remains between the **MIN** and **MAX** indicator marks on the side of the expansion tank.

If the level has dropped suddenly, or by a large amount, arrange for the vehicle to be examined by a Retailer/Authorised repairer as soon as possible.

## TOPPING UP THE COOLANT

**⚠** Never remove the coolant reservoir filler cap when the engine is hot. Escaping steam or scalding water could cause serious personal injury.

**⚠** Unscrew the filler cap slowly, allowing the pressure to escape before removing completely.

**⚠** Antifreeze is highly inflammable. Do not allow antifreeze to come into contact with naked flames or other sources of ignition (e.g., a hot engine) - a fire may result.

**⚠** Antifreeze is poisonous and can be fatal if swallowed. Keep containers sealed and out of the reach of children. If consumption is suspected, seek medical attention immediately.

**⚠** When travelling in territories where the water supply contains salt, always make sure you carry a supply of fresh (rain or distilled) water. Topping up with salt water will cause serious engine damage.

**⚠** The use of non-approved antifreeze will have an adverse effect on the engine's cooling system and; therefore, engine durability.

**⚠** Antifreeze will damage painted surfaces; soak up any spillage with an absorbent cloth immediately, and wash the area with a mixture of car shampoo and water.





Antifreeze contains important corrosion inhibitors. The antifreeze content of the coolant must be maintained at  $50\% \pm 5\%$  all year round (not just in cold conditions). To make sure the anti-corrosion properties of the coolant are retained, the antifreeze content should be checked once a year and completely renewed every ten years, regardless of the distance travelled. Failure to do so may cause corrosion of the radiator and engine components. The specific gravity of a 50% antifreeze solution at  $20^{\circ}\text{C}$  is 1.068 and protects against frost down to  $-40^{\circ}\text{C}$ .

1. Remove the coolant reservoir filler cap by rotating counter-clockwise.
2. Top up to the **MAX** indicator mark on the side of the coolant reservoir. Use a mixture of 50% water and 50% antifreeze. See **264, LUBRICANTS AND FLUIDS**.

**Note:** In an emergency - and only if the approved antifreeze is unavailable - top up the cooling system with clean water, but be aware of the resultant reduction in frost protection. Do not top up or refill with conventional antifreeze formulations. If in doubt, consult a qualified technician.

3. Refit the coolant reservoir filler cap by rotating clockwise, until the cap's ratchet clicks.

## CHECKING THE BRAKE/CLUTCH FLUID LEVEL

-  Seek qualified assistance immediately if brake pedal travel is unusually long, or if there is any significant loss of brake fluid. Driving under such conditions could result in extended stopping distances or complete brake failure.
-  Brake fluid is highly toxic - keep containers sealed and out of the reach of children. If accidental consumption of fluid is suspected, seek medical attention immediately.
-  If the fluid comes into contact with the skin or eyes, rinse immediately with plenty of clean water.
-  Brake fluid is highly inflammable. Do not allow brake fluid to come into contact with naked flames or other sources of ignition (e.g., a hot engine).
-  Do not drive the vehicle with the fluid level below the MIN mark.

If the quantity of fluid in the brake reservoir drops below the recommended level, a red warning lamp in the Instrument panel will illuminate. See **54, BRAKE (RED)**.

**Note:** If the warning lamp illuminates while the vehicle is being driven, stop the vehicle as soon as safety permits by gently applying the brakes. Check and top up the fluid level, if necessary.

With the vehicle on level ground, check the fluid level at least every week (more frequently in high mileage or arduous operating conditions).

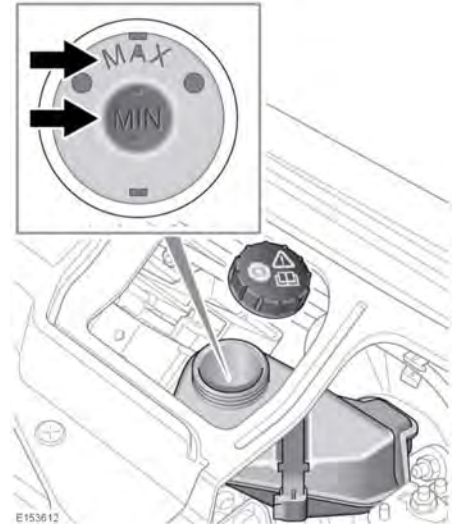

1. Remove the relevant under bonnet cover. See **215, FLUID FILLER LOCATIONS** and **201, UNDER BONNET COVERS - REMOVAL**.
2. Clean the brake fluid reservoir and the filler cap before removing, to prevent dirt from entering the reservoir.

3. Remove the reservoir filler cap by rotating counter-clockwise.
4. Check the brake fluid reservoir level. The level should be between the **MIN** and the **MAX** marks.

**Note:** The fluid level may drop slightly during normal use, as a result of brake pad wear, but should not be allowed to drop below the **MIN** mark.

### TOPPING UP THE BRAKE/ CLUTCH FLUID

- ⚠ Always use brake fluid which has the correct specification. See **264, LUBRICANTS AND FLUIDS**.
  - ⚠ Brake fluid will damage painted surfaces. Soak up any spillage with an absorbent cloth immediately, and wash the area with a mixture of car shampoo and water.
  - ⚠ Only use new fluid from an airtight container (fluid from open containers or fluid previously bled from the system, will have absorbed moisture, which will adversely affect performance, and must not be used).
  - ⚠ Do not top up the brake fluid to the maximum mark unless the brake pads have been renewed. If unsure, seek qualified assistance.
1. Top up the brake fluid reservoir to at least the minimum mark.
  2. Refit the brake fluid reservoir filler cap by rotating clockwise.
  3. Refit the under bonnet cover. See **201, UNDER BONNET COVERS - REFITTING**.

### CHECKING THE WASHER FLUID LEVEL

- ⚠ Do not allow the screen washer fluid to come into contact with naked flames or sources of ignition.
- ⚠ If the vehicle is operated in temperatures below 4°C, use a washer fluid with frost protection.
- ⓘ Only use approved washer fluid.
- ⓘ Take care to avoid spillage, particularly if an undiluted or high concentration is being used. If spillage occurs, wash the affected area immediately with water.

The washer fluid reservoir supplies the front and rear screen washer jets and the headlamp washer jets.

Check and top up the reservoir level at least every week. Always top up with screen washer fluid to prevent freezing.

Operate the washer switches periodically to check that the nozzles are clear and properly directed.

### TOPPING UP THE WASHER FLUID

Top up the washer fluid as follows:

1. Clean the washer fluid reservoir filler cap before removing, to prevent dirt from entering the reservoir.
2. Remove the filler cap.
3. Top up the reservoir until the fluid is visible in the filler neck.
4. Replace the filler cap.