

## AIRBAGS

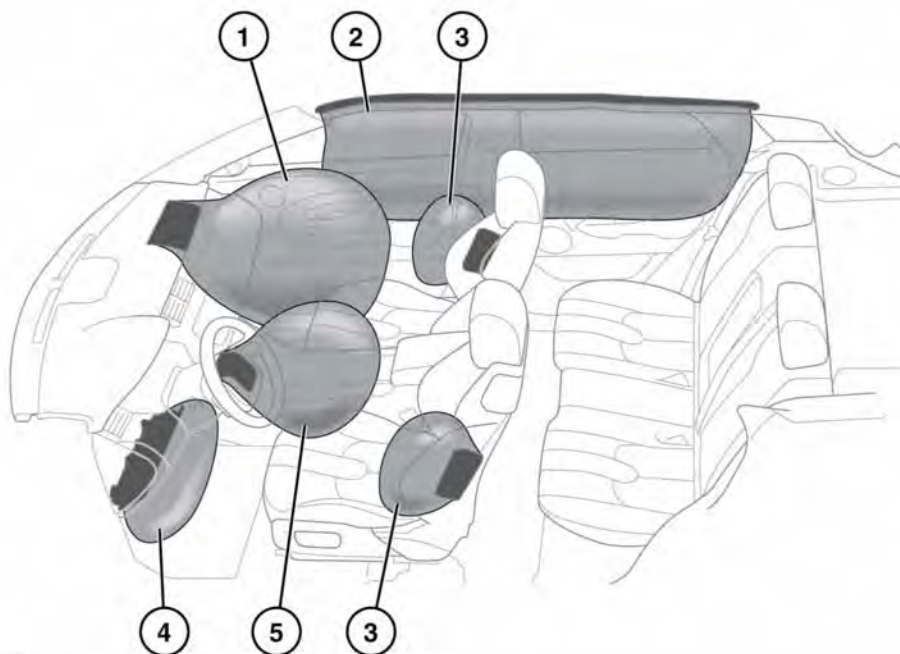

E150268

1. Front passenger's airbag.
2. Curtain airbags.
3. Side airbags.
4. Knee-bolster airbag.
5. Driver's airbag.

**Note:** The general location of airbags fitted to the vehicle are marked by the word AIRBAG.

Always contact your Retailer/Authorised Repairer if:

- An airbag inflates.
- The front or sides of the vehicle are damaged.

- Any part of the airbag Supplementary Restraint System (SRS) shows signs of cracking or damage, including trim covering airbags.
- The amber airbag warning lamp illuminates.





**High speed impacts may cause serious injury or death irrespective of safety features fitted to the vehicle. Always drive with caution and consideration for the vehicle's characteristics, road and weather conditions, and do not exceed any speed limits in force.**

 Seat belts should be worn at all times, by the driver and passengers in all seating positions. The airbag Supplementary Restraint System (SRS) cannot provide protection in some types of impact. Under these circumstances, the only protection will be provided by a correctly worn seat belt.

## AIRBAG OPERATION

Airbags provide additional protection in certain types of collision only - they do not replace the need to wear a seat belt. All occupants, in all seating positions, should always wear their seat belt, whether or not an airbag is present in that seating position.

 For the airbags to operate correctly, the roof lining and door post trims must be in good condition, correctly fitted, and free from obstruction. Any damage, wear, or incorrect fitment should be referred to your Retailer/Authorised Repairer as soon as possible, for examination and repair.

 Airbags inflate at high speeds and can cause facial abrasions and other injuries. To minimise the risk of injury, make sure all vehicle occupants wear correctly positioned seat belts, sit correctly in the seats, and position the seats as far back as is practical.

 Airbag inflation takes place instantaneously and cannot protect against the effects of secondary impacts. Under these circumstances, the only protection will be provided by a correctly worn seat belt.

Airbag deployment is dependent on the rate at which the passenger compartment changes velocity following the collision. Circumstances affecting different collisions (vehicle speed, angle of impact, type and size of object hit, etc.), vary considerably and will affect the rate of deceleration accordingly.

The airbags and Supplementary Restraint System (SRS) are not designed to operate as a result of:

- Rear impacts.
- Minor front impacts.
- Minor side impacts.
- Heavy braking.
- Driving over bumps and pot holes.

Therefore, it follows that considerable superficial damage to the vehicle can occur, without causing the airbags to deploy.

 High speed impacts may cause serious injury or death, irrespective of safety features fitted to a vehicle.

 The airbag SRS cannot provide protection in some types of impact. Under these circumstances, the only protection will be provided by a correctly worn seat belt.

## AIRBAG OBSTRUCTION

 Do not obstruct the operation of the airbags by placing any part of your person or any objects in contact with, or close to, an airbag module. If the airbag inflates, objects or any part of your person could interfere with the inflation of the airbag or be propelled inside the vehicle, causing injury to the occupants.

 Do not allow passengers to obstruct the operation of the airbags by placing feet, knees, or any other part of the body, or any other objects in contact with, or in close proximity to, an airbag module.

Do not place objects between the airbag module and the seat occupant. If the airbag inflates, objects or any part of a person could interfere with the inflation of the airbag or be propelled inside the vehicle, causing injury to the occupants.

 Do not use non-approved seat covers or accessory seat covers that have not been designed for use with airbags. If in doubt, consult your Retailer/Authorised Repairer.

 Make sure that a gap is maintained between the side of the vehicle, and the head and torso. This will enable unobstructed inflation of the curtain, and seat-mounted side airbags.

 Do not attach or position items on, or close to, the roof lining, front seat backrests, or to an airbag cover, which could interfere with the inflation of the airbag or be propelled inside the vehicle, causing injury to the occupants.

Airbags cannot deploy correctly if they are obstructed. Examples of obstructions are:

- Any part of an occupant's body in contact with, or close to, an airbag cover.
- Objects placed on, or close to, an airbag cover.
- Clothing, sun screens, or other material hanging from grab handles.
- Clothing, cushions, or other material covering seat-mounted airbags.
- Seat covers which are not approved by Land Rover, or specifically designed for use with seat-mounted airbags.

This list is not exhaustive and it remains the responsibility of the driver and passengers to make sure the airbags are not obstructed in any way.

## FRONT AIRBAGS

The front passenger and driver airbags are able to deploy in 2 stages, depending on the severity of the frontal impact. In a severe impact, the airbags inflate fully to offer maximum protection. In a lesser impact, full deployment is not required, so the airbags are partially inflated.

The knee-bolster airbag will always fully inflate.

## SIDE AIRBAGS

These are designed to protect the thorax region of the torso and will deploy only in the event of a side impact and then, only on the side of the impact.

## CURTAIN AIRBAGS

The curtain airbags are deployed in side impact and rollover events, providing greater protection from serious head injuries.

 For the curtain airbags to deploy correctly, the roof lining and A-post trim must be undamaged and fitted correctly. Any damage or suspect fitting should be referred to a Retailer/Authorised Repairer for examination.

**Note:** *Curtain airbags will not inflate as a result of frontal or rear impacts alone.*

## AIRBAG DEPLOYMENT EFFECTS

 When an airbag inflates, a fine powder is released. This is normal and not an indication of a malfunction. The powder may cause irritation to the skin and should be thoroughly flushed from eyes and any cuts or abrasions. This powder can cause breathing difficulties for asthma sufferers or other people with respiratory problems. If this occurs, get out of the vehicle as soon as it is safe to do so or get fresh air by opening a window. If breathing problems persist, seek medical attention.

 Airbag deployment is accompanied by a very loud noise, which may cause discomfort, and temporary loss of hearing.

 After inflation, some airbag components will be very hot. Do not touch the airbag components until they have cooled sufficiently.

 After inflation, the front and seat-mounted side airbags deflate immediately. This provides a gradual cushioning effect for the occupants and also makes sure the driver's forward vision is not obscured.

## AIRBAG WARNING LAMP

The airbag warning lamp is displayed in the Instrument panel and will illuminate as a bulb check when the ignition is switched on. See **55, AIRBAG (AMBER)**.

 The warning lamp indicates a potential fault with the vehicle's restraint system, which could result in serious injury or death in the event of a severe accident.

 If the warning lamp indicates that a fault is present in the system, do not use a child restraint on the front passenger seat.

If any of the following warning lamp conditions occur, the vehicle should be checked by your Retailer/Authorised Repairer immediately:

- The warning lamp fails to illuminate when the ignition is switched on.
- The warning lamp fails to extinguish within 6 seconds of the ignition being switched on.

# Airbags

- The warning lamp illuminates at any time, other than during the bulb check, when the ignition is on.

When the ignition is switched on, a diagnostic control unit monitors the readiness of the system's electrical circuits. The elements of the Supplementary Restraint System (SRS) components include:

- SRS warning indicator.
- Rotary coupler.
- Airbag modules.
- Front seat belt pre-tensioners.
- Front seat belt buckle switches.
- Front seat track position sensor.
- Airbag diagnostic control unit.
- Crash and rollover sensors.
- Airbag wiring harness.
- Airbag status indicator.

## DISABLING THE PASSENGER AIRBAG

**Note:** *Disabling the passenger airbag is market dependent.*

The passenger's front airbag can be switched on and off, using the interactive controls on the Instrument panel when the vehicle is stationary. See **49, INSTRUMENT PANEL MENU**

 **The passenger airbag should be disabled only when a child restraint is fitted to the front passenger seat.**

 **Crash test data and statistics show that the safest place for a child to be restrained is in a child seat correctly fitted to the vehicle's rear seat.**



**Do not use a child restraint on a seat protected by an operational airbag in front of it. Doing so presents a high risk of death or serious injury to the child in the event of an accident.**

Select **Passenger Airbag** from the **Vehicle Set-up** menu, located in the **Main Menu**.

The displayed text and diagram will show the current **Passenger Airbag On** or **Off** status. Select **Change Setting** to choose either **On** or **Off**.

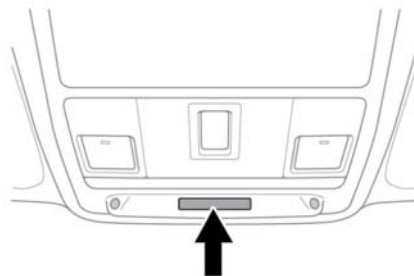





E155462

An airbag status indicator lamp, mounted in the overhead control panel (as illustrated), will display the operational status of the passenger airbag, as shown in the following table.

Setting	Passenger airbag status	Airbag status indicator
Off	Disabled	PASSENGER AIRBAG OFF
On	Activated	ON PASSENGER AIRBAG*

\* Displays for 60 seconds, then extinguishes.

**Note:** The Instrument panel will also display a warning for 4 seconds every time the ignition is switched on.

-  When checking the operational status of the front passenger airbag, make sure the ignition is switched on and the warning lamp bulb check period of 8 seconds has elapsed.
-  As soon as the child seat is removed from the front passenger seat, the airbag must be turned on. Failure to do so will put any front seat passengers at greater risk of death or serious injury in the event of an accident.
-  Do not fit a child restraint to the front passenger seat if the airbag warning lamp illuminates continuously with the ignition on. See 55, AIRBAG (AMBER).
-  The passenger airbag must be disabled when a rearward facing child restraint is fitted to the front passenger seat.

## AIRBAG SERVICE INFORMATION

-  Phone systems should only be installed by qualified persons familiar with the operation of, and requirements for, vehicles fitted with a Supplementary Restraint System (SRS). If you are in any doubt, seek advice from your Retailer/Authorised Repairer.

-  Do not attempt to service, repair, replace, modify, or tamper with, any part of the SRS. This includes wiring or components in the vicinity of SRS components. Doing so may cause the system to trigger, or render the system inoperative.

-  Do not use any electrical test equipment or devices in the vicinity of SRS components or wiring. Doing so may cause the system to trigger, or render the system inoperative.

-  For your safety, all of the following operations should only be carried out by a Retailer/ Authorised Repairer, or suitably qualified person:

- Removal, or repair, of any wiring or component in the vicinity of any SRS components.
- Fitment of electrical, or electronic, equipment and accessories.
- Modification to the front or sides of the vehicle's exterior.
- Attachment of accessories to the front or sides of the vehicle.

Always contact your Retailer/Authorised Repairer if:

- An airbag inflates.
- The front or sides of the vehicle are damaged.
- Any part of the airbag SRS shows signs of cracking or damage, including the trim covering the airbags.

## **DISABILITY MODIFICATIONS**

Occupants with disabilities which may require the vehicle to be modified, must contact a Retailer/Authorised Repairer before any modifications are made.