

SINGLE LOCKING

Press the lock button on the Smart key briefly to single lock the vehicle and activate the perimeter alarm. The hazard warning lamps will flash to confirm.

Single locking secures the vehicle and prevents the doors from being opened from the outside. The doors may still be unlocked and opened from inside the vehicle. In this state, only the perimeter alarm is activated. See **13, PERIMETER ALARM**.

Note: *This setting should be used in circumstances, such as travelling on a ferry, when pets are to be left in the vehicle, or if a window must be left open etc.*

Note: *Always secure your vehicle when left unattended. Where possible, always secure your vehicle to the maximum available level of security.*

DOUBLE LOCKING



Never double lock the vehicle with people, children, or pets inside. In the event of an emergency they would be unable to escape and the emergency services would be unable to release them quickly.

Press the lock button on the Smart key twice within 3 seconds to double lock the vehicle and activate the full alarm system. The hazard warning lamps will flash twice to confirm and a double lock tone will sound..

Double locking secures the vehicle and prevents the doors being opened from inside or outside of the vehicle. The doors cannot be unlocked or opened from inside the vehicle when double locked.

This provides extra security if the vehicle is left unattended. The vehicle cannot be opened by breaking a window and operating the door locks from inside. Additionally, double locking also activates the full alarm system. See **13, FULL ALARM**.

Note: *In this state, an open window or sunroof will cause the alarm to sound due to the movement of air currents. For this reason, make sure that all windows and the sunroof are fully closed before double locking the vehicle.*

PERIMETER ALARM

The perimeter alarm system is activated when the vehicle is single locked. See **13, SINGLE LOCKING**. Once activated, the alarm system will sound if;

- the bonnet, tailgate or a door is opened.
- the engine **START/STOP** button is pressed without a valid Smart key present.

If the vehicle is fitted with a battery backed-up sounder, the sounder will sound if the battery is disconnected, or an attempt is made to disconnect the sounder.

FULL ALARM

The full alarm system is activated when the vehicle is double locked. See **13, DOUBLE LOCKING**. Once activated the alarm system will sound if:

- The bonnet, tailgate or a door are opened.
- Movement is detected within the vehicle interior.
- The vehicle is raised or tilted.

If the vehicle is fitted with a battery backed-up sounder, the alarm system will also sound if:

- The vehicle battery is disconnected.
- An attempt is made to disconnect the battery backed-up sounder.

Exiting the vehicle

INTERIOR PROTECTION

The interior protection feature of the full alarm system may be temporarily disabled via the **Vehicle Set-Up** menu. See **46, INSTRUMENT PANEL MENU**.

Note: Once disabled, this setting will be re-enabled the next time the vehicle is double locked with the Smart key.

KEYLESS LOCKING

 **Never double lock the vehicle with people, children or pets inside. In the event of an emergency they would be unable to escape and the emergency services would be unable to release them quickly.**

 The vehicle will not lock automatically.

 The Smart key may not be detected if it is placed within a metal container or if it is shielded by a device with a back-lit LCD screen, such as a smart phone, laptop (including in a laptop bag), games console etc.

Note: Loose coins in the same pocket as the Smart key may also affect its detection.

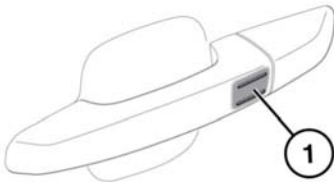

E149763

Note: Keyless locking will activate only if the Smart key is detected outside the vehicle. If no Smart key is present, no locking will occur.

- To single lock the vehicle touch only the keyless locking sensor (1) once without grabbing the door handle.

Note: Do not place your fingers around the back of the door handle while touching the sensor. Doing so will prevent the vehicle from locking.

- The hazard warning lamps will flash once to confirm locking and the power fold mirrors will fold in (if enabled).
- To double lock the vehicle, touch only the keyless locking sensor (1) twice within 3 seconds.

Note: Do not place your fingers around the back of the door handle while touching the sensor. Doing so will prevent the vehicle from locking.

- The hazard warning lamps will flash twice accompanied by an audible sound to confirm locking .

Note: When locking the vehicle via Keyless locking, if a valid key is not present, 1 or more of the doors, the bonnet or the tailgate is not fully closed, or the ignition is ON, the vehicle will NOT lock. There will be NO audible mislock error warning. The hazard warning lamps will NOT flash and the door mirrors (if enabled) will NOT fold in. Check that all doors, the bonnet and the tailgate are closed properly. Make sure that the ignition is turned OFF and lock the vehicle again. If the mislock persists, consult a Dealer/Authorised Repairer.

GLOBAL CLOSING

 **Make sure that no children, pets, or obstructions are in any open aperture before operating global closing. Safety mechanisms are in place to prevent serious injury, however injuries can still occur.**

Press and hold the lock button on the Smart key for 3 seconds. The vehicle will single lock and the perimeter alarm will be activated immediately. After 3 seconds any open windows and the sunroof will be closed. Press the lock button twice in 3 seconds to double lock the vehicle.

This feature can be enabled/disabled via the **Vehicle Set-Up** menu. See **46, INSTRUMENT PANEL MENU**.

With a valid Smart key present, press and hold the keyless locking sensor (if fitted) on any exterior door handle. The vehicle will single lock and the perimeter alarm will be activated immediately. After approximately 3 seconds, any open windows and the sunroof will begin to close.

Keep the keyless locking sensor pressed until all open windows and the sunroof are fully closed. Releasing the keyless locking sensor will stop all window and sunroof movement.

When all windows and sunroof are closed, release and then press the keyless locking sensor to confirm the vehicle is single locked. Alternatively, press the keyless locking sensor twice within 3 seconds to double lock the vehicle.

This feature can be enabled/disabled via the **Vehicle Set-Up** menu. See **46, INSTRUMENT PANEL MENU**.

DOOR LOCKS AND RELEASE LEVERS



While a door is open, the locking latch is exposed. If your vehicle is fitted with the soft close feature, do not attempt to manually close the latch as it may also automatically 'soft close' and trap items or body parts.

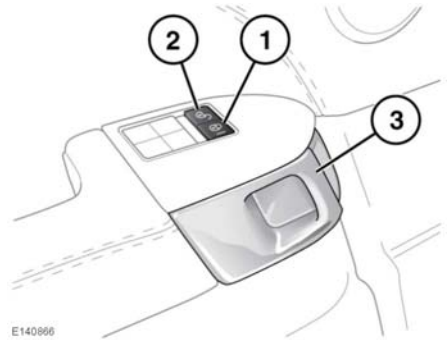

1. Lock:
 - With all doors closed, press any lock button to lock all doors.
2. Unlock:
 - Press any unlock button to unlock all doors. Alternatively, pull either front door release handle (3) once to unlock all doors.
 - Pull either rear door release handle (3) once to unlock the individual rear door.

Note: All unlock buttons are inhibited when the vehicle is locked with the Smart key.

3. Door release handle: pull to unlock and open the door(s). If the door is locked, pulling either front door handle once will unlock all doors. Pulling either rear door handle once will unlock the individual rear door.

Note: The rear child security feature will inhibit the rear door lock (1) and unlock (2) switches, and the door release handles (3).
33, CHILD SAFETY LOCKS

Exiting the vehicle

MISLOCK

When attempting to lock the vehicle with the Smart key, if a valid key isn't present, if 1 or more of the doors, the bonnet or the tailgate is not fully closed or the ignition is ON, the vehicle will NOT lock and an audible warning will sound twice. Make sure the ignition is turned off and lock the vehicle again. The vehicle will NOT fully lock until all doors, the bonnet and the tailgate are completely closed.

An audible mislock warning will also sound if on locking, the system detects a lock or latch failure. If the mislock persists, consult your Dealer/Authorised Repairer.

DEACTIVATING THE ALARM WHEN TRIGGERED

If the alarm has been triggered it can be deactivated by pressing the Smart key unlock button, or by positioning the Smart key against the steering column and pressing the engine **START/STOP** button. See **98, KEYLESS START BACKUP**.

EMERGENCY LOCKING

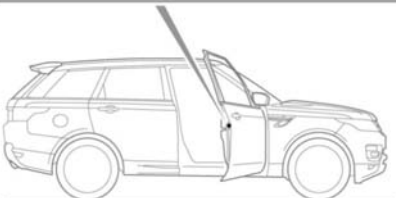
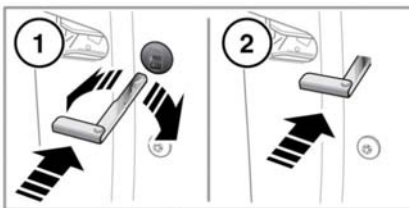

E149765

In the event of the battery discharging or a fault with the keyless locking system, the doors must be locked manually.

Note: Do not leave the emergency key blade in the vehicle at any point during the emergency locking procedure.

1. Open the door and locate the emergency lock access cover. Using the emergency key blade (see **5, UNLOCKING THE VEHICLE**) rotate the cover to release it from the door. Remove the cover and store it safely.
2. Insert the emergency key blade firmly into the emergency lock. The emergency key blade can now be removed.
3. Refit the emergency lock access cover and rotate it clockwise to secure it firmly.
4. Close the door and check to make sure the door is locked. Repeat the procedure for all other unlocked doors.