

AIRBAGS

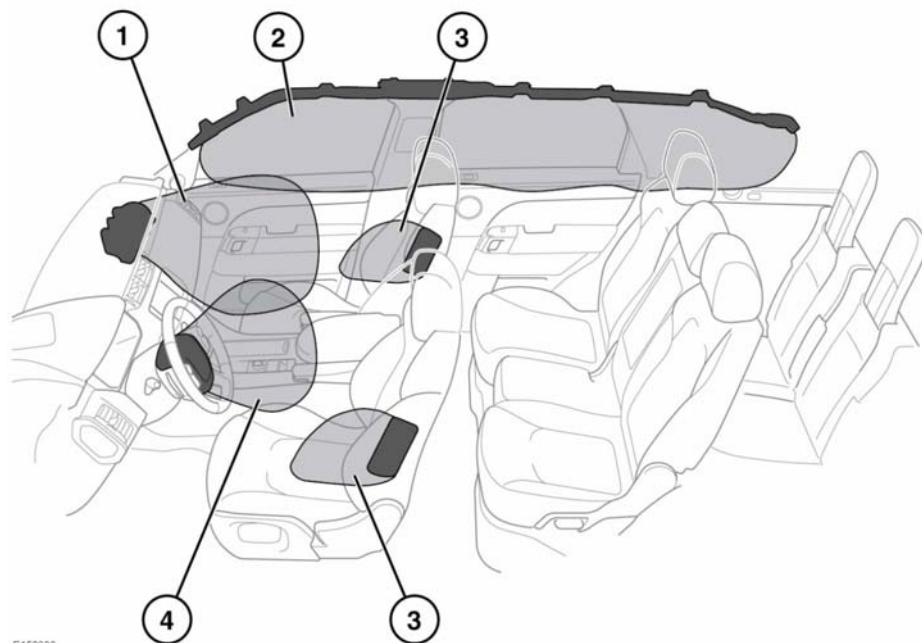

E150836

1. Passenger front airbag.
2. Curtain airbag.
3. Side airbags.
4. Driver's front airbag.

Note: The general location of airbags fitted to the vehicle are marked by the word AIRBAG.

Always contact your Dealer/Authorised Repairer if:

- An airbag inflates.
- The front or sides of the vehicle are damaged.
- Any part of the airbag system shows signs of cracking or damage, including trim covering airbags.

AIRBAG OPERATION



For the airbags to operate correctly the roof lining and door post trims must be in good condition, correctly fitted, and free from obstruction. Any damage, wear, or incorrect fitment should be referred to your Dealer/ Authorised Repairer as soon as possible for examination and repair.



Do not allow passengers to obstruct the operation of the airbags by placing any part of their person, or any objects, in contact with, or close to, an airbag module. Only use approved accessories (e.g. seat covers).



Make sure a gap is maintained between the side of the vehicle, and the head and torso. This will enable unobstructed inflation of the curtain, and seat mounted side airbags.



Airbags inflate at high speeds. To minimise the risk of injury, make sure all vehicle occupants wear correctly positioned seat belts, sit correctly in the seats, and position the seats as far back as practical.



Airbag inflation takes place instantaneously, and cannot protect against the effects of secondary impacts. Under these circumstances the only protection will be provided by a correctly worn seat belt.



Phone systems should only be installed by qualified persons familiar with the operation of, and requirements for, vehicles fitted with SRS. If you are in any doubt, seek advice from your Dealer/Authorised repairer.

Airbag deployment is dependent on the rate at which the passenger compartment changes velocity during a collision. Circumstances affecting different collisions (vehicle speed, angle of impact, type and size of object hit, etc.), vary considerably and will affect the rate of deceleration accordingly.

Airbags cannot deploy correctly if they are obstructed. Examples of obstructions are:

- Any part of an occupants body in contact with, or close to, an airbag cover.
- Objects placed on, or close to, an airbag cover.
- Clothing, sun screens, or other material hanging from grab handles.
- Clothing, cushions, or other material, covering seat mounted airbags.
- Seat covers which are not approved by Land Rover, or specifically designed for use with seat mounted airbags.

This list is not exhaustive, and it remains the responsibility of the driver and passengers to make sure the airbags are not obstructed in any way.

The airbags and SRS are not designed to operate as a result of:

- Rear impacts.
- Minor front impacts.
- Minor side impacts.
- Heavy braking.
- Driving over bumps and pot holes.



High speed impacts may cause serious injury or death irrespective of safety features fitted to a vehicle.



The airbags and SRS cannot provide protection in some types of impact. Under these circumstances the only protection will be provided by a correctly worn seat belt.

Airbags

FRONT AIRBAGS

The front passenger and driver airbags have 2 levels of deployment, depending on the severity of the frontal impact. In a severe impact, the airbags inflate fully to offer maximum protection. In a lesser impact, full deployment is not required, so the airbags are inflated to a reduced pressure.

SIDE AND CURTAIN AIRBAGS

The seat mounted side airbags are designed to protect the thorax region of the torso and will deploy only in the event of a side impact and then, only on the side of the impact.

Both sides will deploy in the event of a rollover.

The curtain airbags are deployed in side impact and rollover events, providing greater protection from serious head injuries. They deflate at a slower rate than the front or side air bags.

AIRBAG DEPLOYMENT EFFECTS



When an airbag inflates, a fine powder is released. This is normal and not an indication of a malfunction. The powder may cause irritation to the skin and should be thoroughly flushed from eyes and any cuts or abrasions.



Airbag deployment is accompanied by a very loud noise which may cause discomfort and temporary loss of hearing.



Airbags inflate at high speed and can cause injuries. To minimise the risk of injury, make sure all occupants wear correctly positioned seat belts, sit correctly in the seats and position the seats as far back as is practicable.



After inflation, some airbag components will be very hot. Do not touch the airbag components until they have cooled sufficiently.

AIRBAG WARNING LAMP



If the warning lamp indicates that a fault is present in the system, do not use a child restraint on the front passenger seat.

If any of the following warning lamp conditions occur, the vehicle should be checked by your Dealer/Authorised Repairer immediately.

- The warning lamp fails to illuminate when the ignition is turned on.
- The warning lamp fails to extinguish after 8 seconds of the ignition being turned on.
- The warning lamp illuminates at any time, other than the bulb check, when the ignition is turned on.

When the ignition is switched on, a diagnostic control unit monitors the readiness of the system's electrical circuits. The elements of the Supplementary Restraint System (SRS) being monitored include:

- SRS warning indicator.
- Rotary coupler.
- Airbag modules.
- Seat belt pre-tensioners (front and 2nd row rear seat belts).
- Front seat belt buckle switches.
- Airbag diagnostic control unit.
- Crash and rollover sensors.
- Airbag wiring harnesses.

DISABLING THE PASSENGER AIRBAG

Note: *Disabling the passenger airbag is market dependent.*

The passenger front airbag can be switched on and off using the interactive controls on the Instrument panel when the vehicle is stationary. See **46, INSTRUMENT PANEL MENU**

 **The passenger airbag should be disabled only when a child restraint is fitted to the front passenger seat.**

 **Crash test data and statistics show that the safest place for a child to be restrained is in a child seat correctly fitted to the vehicle's rear seat.**

 **Do not use a child restraint on a seat protected by an operational airbag in front of it. Doing so presents a high risk of death or serious injury to the child in the event of an accident.**

Select **Passenger Airbag** from the **Vehicle Setup** menu, located in the **Main Menu**.

The displayed text and diagram will show the current **Passenger Airbag On** or **Off** status. Select **Change Setting** to choose either **On** or **Off**.

A warning lamp in the roof console will illuminate if **Passenger Airbag Off** setting is selected.

Note: *The Instrument panel will also display a warning for 4 seconds every time the ignition is switched on.*

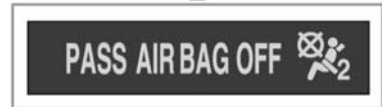

E142744

 **As soon as the child seat is removed from the front passenger seat, the airbag must be turned on. Failure to do so, will put any front seat passengers at greater risk of death or serious injury in the event of an accident.**

 **When checking the operational status of the front passenger airbag, make sure the ignition is switched on.**

 **Do not fit a child restraint to the front passenger seat if the SRS warning light illuminates continuously with the ignition on.**

AIRBAG SERVICE INFORMATION

 **Do not attempt to service, repair, replace, modify, or tamper with, any part of the SRS. This includes wiring or components in the vicinity of SRS components. Doing so may cause the system to trigger, or render the system inoperative.**



Do not use any electrical test equipment or devices in the vicinity of SRS components or wiring. Doing so may cause the system to trigger, or render the system inoperative.

All of the following operations should only be carried out by a Dealer/Authorised Repairer, or suitably qualified person:

- Removal or repair of any wiring or component in the vicinity of any SRS components.
- Installation of electrical, or electronic, equipment and accessories.
- Modification to the front or sides of the vehicle exterior.
- Attachment of accessories to the front or sides of the vehicle.

DISABILITY MODIFICATIONS

Occupants with disabilities which may require modification of the vehicle, must contact a Dealer/Authorised Repairer before any modifications are made.