

BUSINESS CLASS SEATS

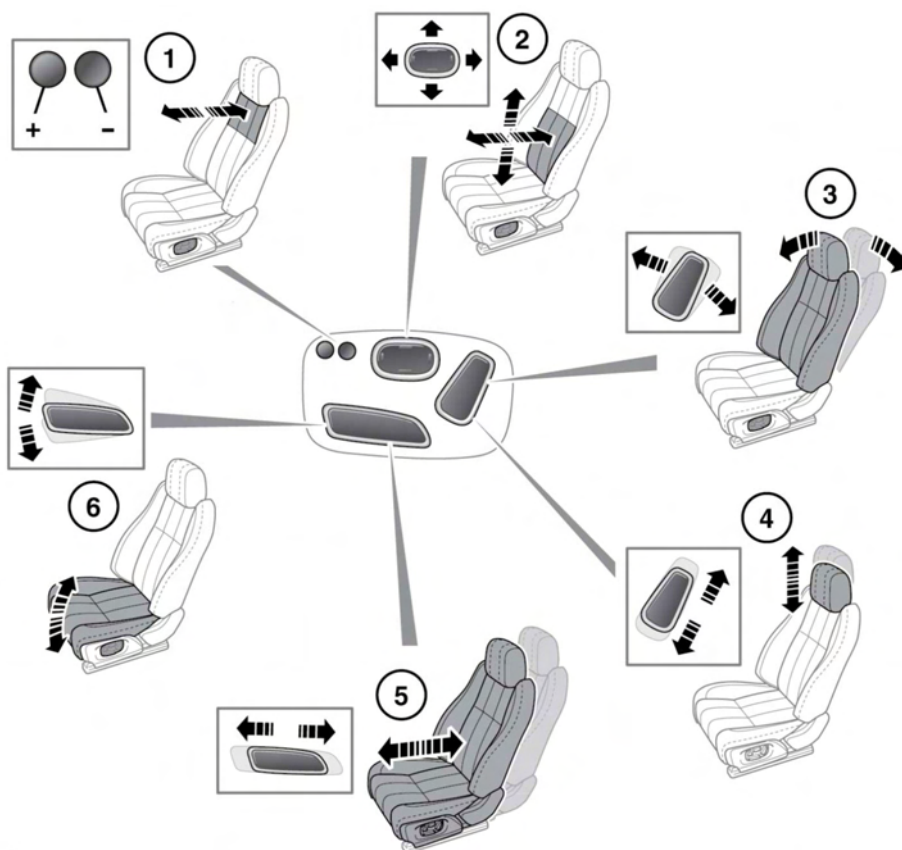

E144837

1. Upper seat back angle.
2. Lumbar support.
3. Seat back angle.
4. Head restraint height.
5. Forward and rearward position.
6. Cushion tilt.

The business class seats also have:

- Climate control (see **84, REAR CLIMATE CONTROL**).
- Seat massage (see **24, MASSAGE SEATS**).

ELECTRIC SEATS

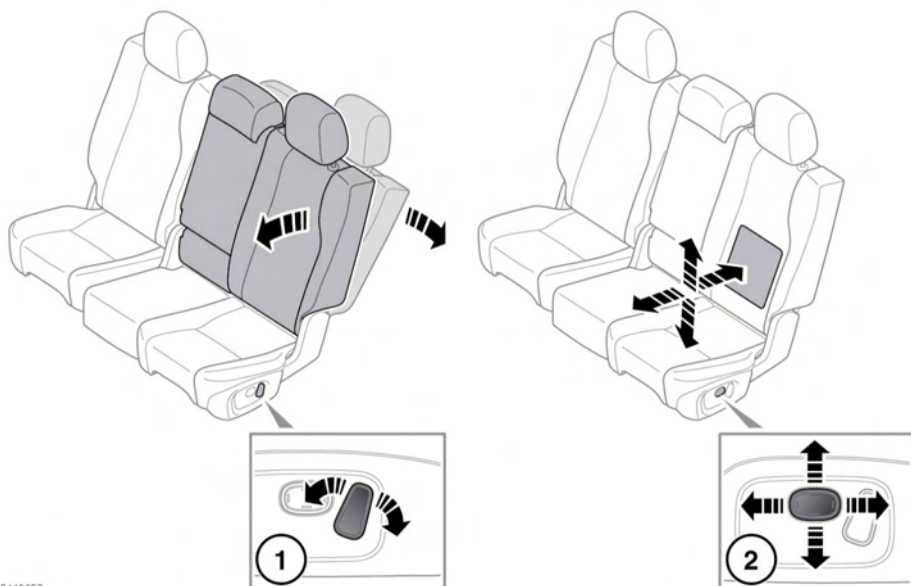

E140657

1. Seat back angle.
2. Lumbar Support.

Rear seats

MANUAL SEATS

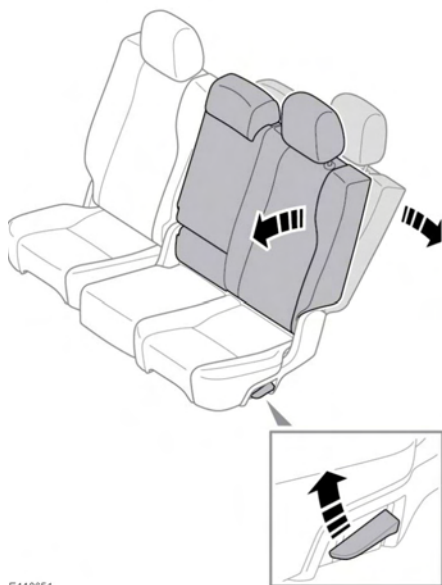

E140651

To adjust the angle of the seat back:

1. Lift the adjustment lever.
2. Adjust the seat back to the desired angle.
3. Release the adjustment lever.

MASSAGE SEATS

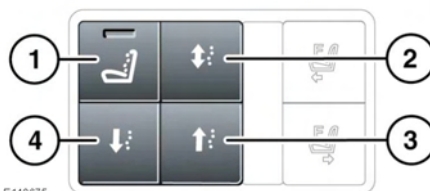

1. Massage on/off.

Note: Massage seats will only operate with the engine running.

2. Bi-directional massage.
3. Upward massage.
4. Downward massage.

Note: Massage programs have a specific timed cycle, which will need to be re-selected for continuous use.

PASSENGER SEAT AWAY

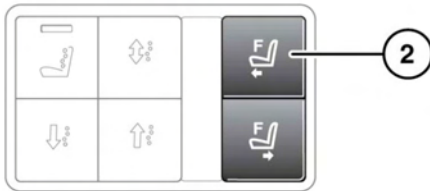
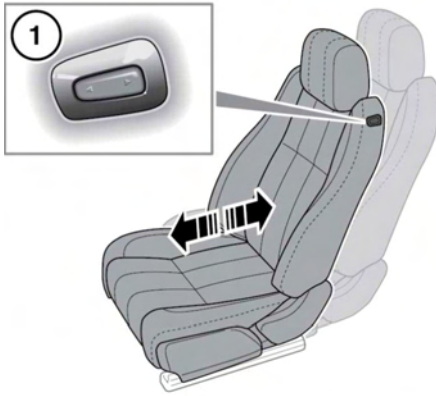

E140676

1. Located on the front passenger seat.
2. Located on the rear center console (Business class rear seats only).

The front passenger seat position can be adjusted to provide more space for rear seat occupants. Use the relevant switch for forward or rearward adjustment.

FOLDING AND RAISING THE REAR SEATS

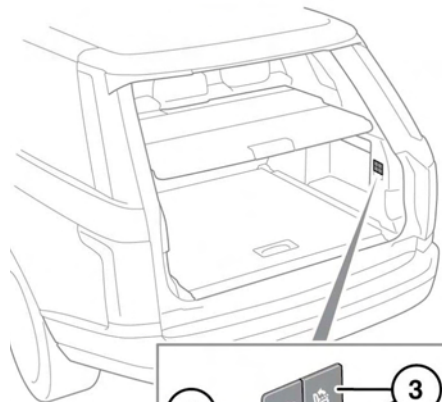
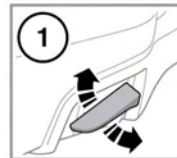

E140665

Rear seats

⚠ WARNING

Never allow passengers to ride in the cargo area. In a collision, people riding in these areas are more likely to be seriously injured or killed. Do not allow anyone to ride in any area of your vehicle that is not equipped for passengers. Be sure everyone in your vehicle is in a seat and using their seat belt properly.

⚠ WARNING

In a collision or sudden stop, unsecured objects could be thrown inside the vehicle striking and injuring occupants. Always properly store and secure cargo and other objects in the vehicle.

⚠ WARNING

Make sure that when the seatback is raised, the locking mechanism is fully engaged.

⚠ WARNING

When erecting the rear seats, ensure that seat belts are correctly routed in the seat belt guides and not trapped behind the seats.

⚠ WARNING

Make sure the head restraints are raised to the correct position before the seats are used by a passenger.

The split fold rear seat can be folded completely to accommodate large loads, or partially to accommodate large loads and still retain seating for passengers.

1. Manual seats: raise the release lever. The seatback will fold down against the seat cushion. Lift the seatback to raise to the upright position and ensure the seatback is locked firmly in position.
2. Electric seats: press to fold/raise the left-hand seatback.
3. Electric seats: press to fold/raise the right-hand seatback.

Note: If the electric seats are operated more than 3 times through the full fold/raise sequence in quick succession, the system will be disabled for 2 minutes.