





## FRONT HEAD RESTRAINTS

-  **Adjust the head restraint so that the top of the head restraint is above the centre line of the head. An incorrectly adjusted head restraint increases the risk of death or serious injury in the event of a collision.**
-  **Do not drive, or carry passengers with the head restraints removed from occupied seats. The absence of a correctly adjusted head restraint increases the risk of neck injury in the event of a collision.**
-  **Never adjust the head restraints while the vehicle is in motion.**
-  **Always store a removed head restraint securely.**

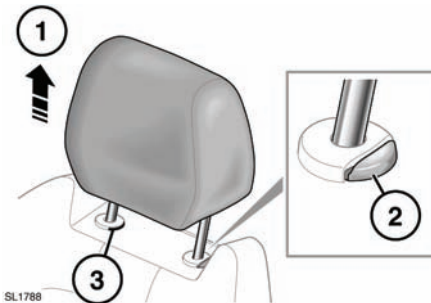

1. Move the head restraint up to the required position.
2. To adjust the restraint downwards, first press in the adjusting collar.
3. To remove a manual head restraint, first raise the head restraint to its uppermost position. Press in the locking collar. Lift the restraint out of the seatback

**Note:** Head restraints fitted with Rear seat entertainment screens must NOT be removed.



Ensure the head restraint is refitted before the seat is used by a passenger.

To refit the head restraint, ensure it is facing the correct direction, insert the stems of the head restraint into the sockets and push it downwards until at least the first click.

## INTEGRATED HEAD RESTRAINTS

Models with 'sports' front seats have non adjustable and non removable head restraints.

## REAR SEAT HEAD RESTRAINTS

-  **Adjust the head restraint so that the top of the head restraint is above the centre line of the head. An incorrectly adjusted head restraint increases the risk of death or serious injury in the event of a collision.**
-  **Do not drive or carry passengers with the head restraint removed from an occupied seat. The absence of a correctly adjusted head restraint increases the risk of neck injury in the event of a collision.**
-  **Always store a removed restraint securely.**

Head restraints may be removed, if required (e.g. to fit larger child seats). To remove a head restraint, first raise the head restraint to its uppermost position. With the adjusting collar pressed in, lift the restraint out of the seatback.

To refit a head restraint, ensure it is facing the correct direction, insert the stems of the head restraint into the sockets and push it downwards until at least the first click.

## Head restraints

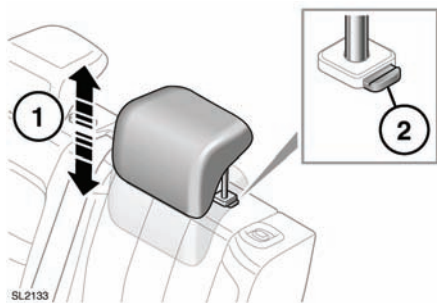

1. To raise, pull the restraint upwards.
2. To lower, press in the adjusting collar and push down on the restraint.