

## STORAGE COMPARTMENTS

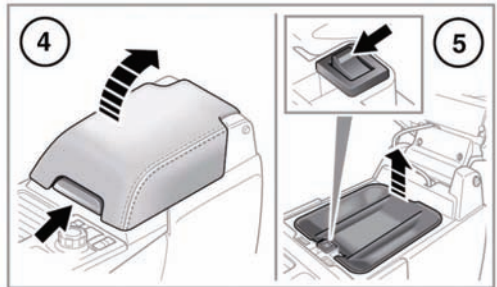

E135112

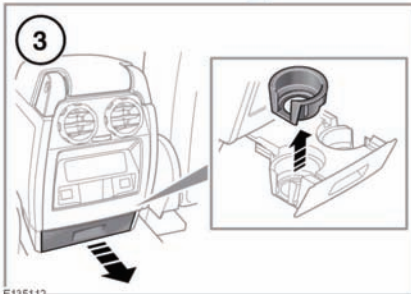
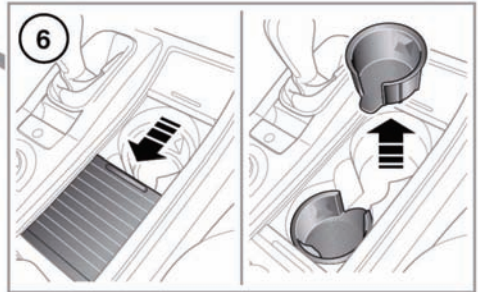
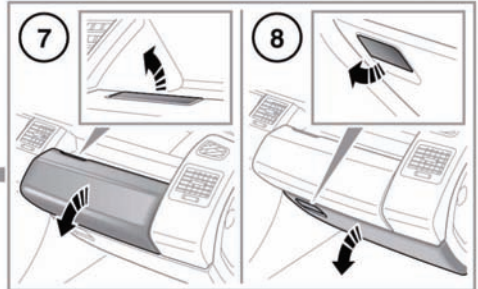
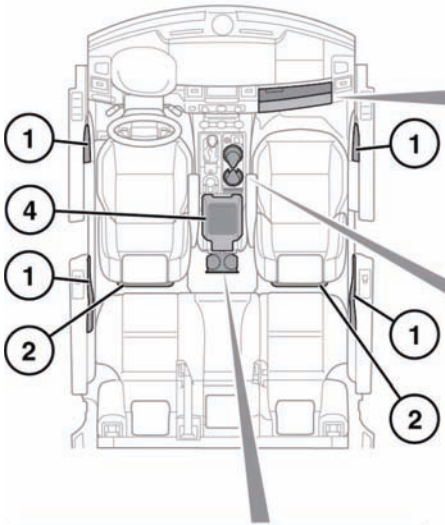

Ensure that any items stored in the vehicle are secure and cannot move. If the vehicle is involved in an accident, or subject to sudden braking or direction change, loose items can cause serious injury.



Do not drink, or use the cup holders when driving.

1. Storage bins.
2. Map pockets.

3. Rear seat cup holders: Pull out drawer to access. Lift out cup holder insert for cleaning.

4. Centre console storage/cool box.

**Note:** The rubber mat at the bottom of the centre console is designed to hold CD cases.

# Storage compartments

5. Cool box: Switch on and off using the switch on the inside front lip. There is a short delay between pressing the switch and illumination of the indicator.

The cool box will work best when the cooling tray is used.

**Note:** The cool box will only operate with the ignition turned on.



The cool box should be switched off when it is not needed, to preserve battery charge.

6. Front cup holders: Slide open the panel to access. Lift the cup holder insert out for cleaning.
7. Glovebox.
8. Lower glovebox.

## Auxiliary power sockets

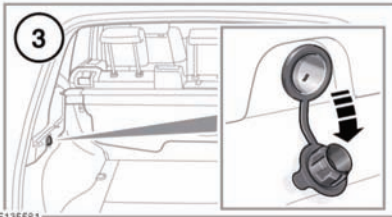
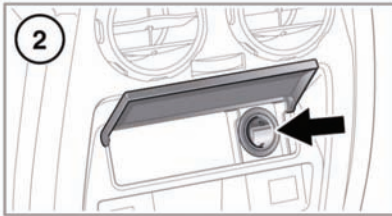
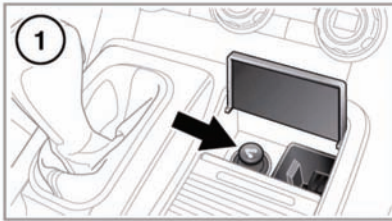

E135581

1. Front power socket.
2. Rear power socket.
3. Loadspace power socket.



Only use Land Rover approved accessories. Using any other equipment may damage the vehicle's electrical system. If you are in any doubt contact a Land Rover Dealer/ Authorised Repairer.

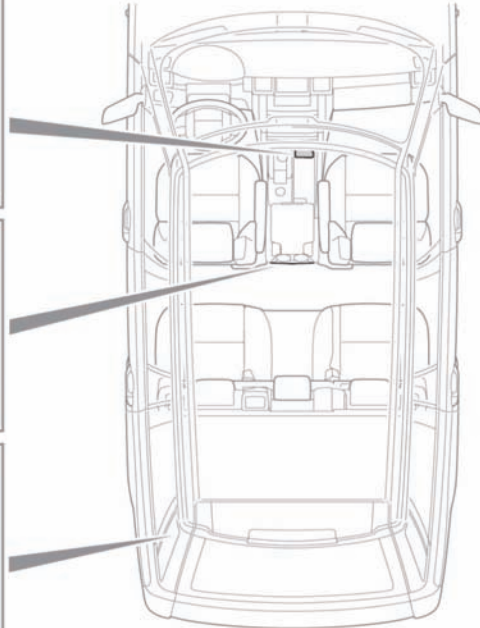

The engine should be running when using accessories for long periods. Failure to do so can discharge the battery.

**Note:** Power sockets can be used to power approved accessories that use a maximum of 180 Watts.