

TYRE REPAIR KIT



If you are in any doubt regarding your ability to carry out the instructions, contact your Dealer/Approved Repairer before attempting the repair.

Your vehicle may not be equipped with a spare tyre. If this is the case, your vehicle will be fitted with a Land Rover tyre repair kit which can be used to repair one tyre. It is essential that you read the following guide before attempting to repair a tyre.

The tyre repair kit seals most punctures with a maximum diameter of 6 mm (1/4 inch).

The tyre repair kit is located in the rear underfloor storage compartment.

Note: *The sealant used in the tyre repair kit has a shelf life, and the expiry date is shown on the top of the bottle. Ensure that the bottle is replaced before the expiry date.*

SAFETY INFORMATION



Some tyre damage may only be partially sealed, or may not seal at all, depending on the amount and type of damage. Any loss of tyre pressure can seriously affect vehicle safety.



Do not use the tyre repair kit if the tyre has been damaged by driving while under inflated.



Only use the tyre repair kit to seal damage located within the tyre tread area.



Do not use the tyre repair kit to seal damage to the tyre sidewall.



Do not exceed 80 km/h (50 mph) when a repaired tyre is fitted to the vehicle.



The maximum distance that should be driven when a repaired tyre is fitted, is 200 km (125 miles).



When a repaired tyre is fitted, drive with caution and avoid sudden braking or steering manoeuvres.



Only use the tyre repair kit for the vehicle with which it was supplied.



Do not use the tyre repair kit for any other purpose than tyre repair.



Never leave the tyre repair kit unattended when in use.



Only use the tyre repair kit within the -30°C to +70°C temperature range.



Always keep children and animals at a safe distance from the tyre repair kit when in use.



Do not stand directly beside the compressor when it is operating.



Check the tyre sidewall prior to inflation. If any cracks, damage, or deformities are apparent do not inflate the tyre.



Watch the tyre sidewall during inflation. If any cracks, damage, or deformities are apparent switch off the compressor, and deflate the tyre.

Tyre repair kit

LAND ROVER TYRE REPAIR KIT

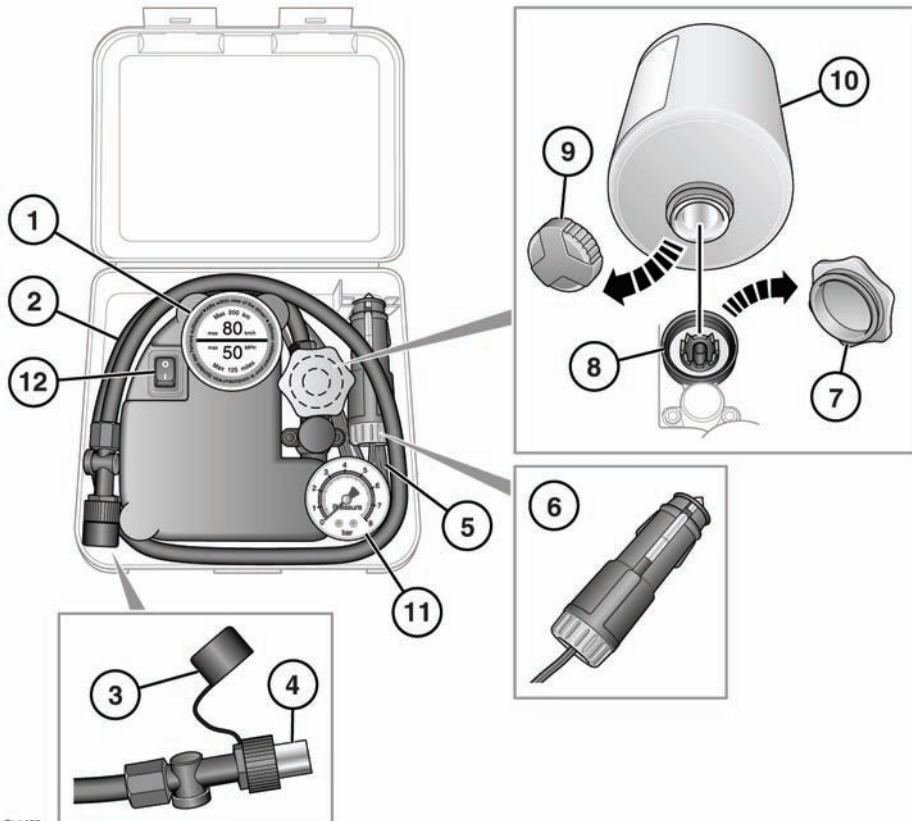

SL1452

1. Maximum speed label. 80 km/h (50 mph).
2. Tyre inflation hose.
3. Inflation hose protective cap.
4. Inflation hose connector.
5. Compressor power cable.
6. Power cable connector.
7. Sealant bottle receiver cap (orange).
8. Sealant bottle receiver.
9. Sealant bottle cap.
10. Sealant bottle.
11. Tyre pressure gauge.
12. Compressor on/off switch (**I** = on, **O** = off).

USING THE REPAIR KIT



Avoid skin contact with the sealant which contains natural rubber latex. Do not unscrew the sealant bottle from the receiver until it is empty, as sealant will leak out.



If the tyre inflation pressure does not reach 1.8 bar (26 lb/in²) within seven minutes, the tyre may have suffered excessive damage. A temporary repair will not be possible, and the vehicle should not be driven until the tyre has been replaced.



Before attempting a tyre repair, ensure that the vehicle is parked safely, as far away from passing traffic as possible.



Ensure that the parking brake is applied, and P is selected if an automatic transmission is fitted.



Do not attempt to remove foreign objects such as nails, screws, etc. from the tyre.



Always run the engine when using the compressor, unless the vehicle is in an enclosed, or poorly ventilated space.



To prevent overheating do not operate the compressor continuously for longer than ten minutes.

Note: All vehicle drivers and occupants should be made aware that a temporary repair has been made to a tyre fitted to the vehicle. They should also be made aware of the special driving conditions imposed when using a repaired tyre.

REPAIR PROCEDURE



Check the tyre sidewall prior to inflation. If there are any cracks, bumps or similar damage, do not attempt to inflate the tyre. Do not stand directly beside the tyre while the compressor is pumping. Watch the tyre sidewall: If any cracks, bumps or similar damage appear, turn off the compressor and let the air out by means of the pressure relief valve. Do not continue to use the tyre.

1. Open the tyre repair kit and peel off the maximum speed label. Attach the label to the fascia in the driver's field of view. Take care not to obstruct any of the instruments or warning lights.
2. Uncoil the compressor power cable and the inflation hose.
3. Unscrew the orange cap from the sealant bottle receiver, and the sealant bottle cap.
4. Screw the sealant bottle into the receiver (clockwise) until tight.
 - Screwing the bottle onto the receiver will pierce the bottle's seal.
5. Remove the valve cap from the damaged tyre.
6. Remove the protective cap from the inflation hose, and connect the inflation hose to the tyre valve. Ensure that the hose is screwed on firmly.
7. Ensure that the compressor switch is in the off (O) position.
8. Insert the power cable connector into an auxiliary power socket. See **70, AUXILIARY POWER SOCKETS**.
9. Unless the vehicle is in an enclosed area, start the engine.

10. Set the compressor switch to the on (I) position.
11. Inflate the tyre to a minimum of 1.8 bar (26 lbf/in²) and a maximum of 3.5 bar (51 lbf/in²).
 - When pumping the sealant through the tyre valve, the pressure may rise up to 6 bar (87 lbf/in²). The pressure will drop again after approximately 30 seconds.
12. During the inflation, switch the compressor off briefly to check the tyre pressure using the gauge mounted on the compressor.
 - It should not take longer than seven minutes to inflate the tyre. If after seven minutes the tyre has not reached the minimum pressure, the tyre should not be used.
13. Once the tyre has been inflated, switch off the compressor. If desired, the engine may be turned off after the compressor has been turned off.
14. Remove the power connector from the auxiliary power socket.
15. Remove the inflation hose from the tyre valve by unscrewing it as quickly as possible (anticlockwise).
16. Replace the inflation hose protective cap, and the tyre valve cap.
17. Do not remove the sealant bottle from the receiver.
18. Ensure that the tyre repair kit (including the bottle, and receiver caps) are placed securely in the vehicle. You will need to use the kit to check the tyre pressure after 3 km (2 miles) so ensure they are easily accessible.

19. Immediately drive the vehicle for 3 km (2 miles) to allow the sealant to coat the inner surface of the tyre and form a seal at the puncture.

CHECKING THE TYRE PRESSURE AFTER A REPAIR



When driving the vehicle, if you experience vibrations, abnormal steering, or noises, reduce speed immediately. Drive with extreme caution and reduced speed to the first safe place to stop the vehicle. Visually examine the tyre, and check its pressure. If there are any signs of damage or deformity to the tyre, or the tyre pressure is below 1.3 bar (19 lbf/in²), do not continue driving.



Consult a tyre repair centre, or your Dealer/Authorised Repairer for advice concerning the replacement of a tyre after using a tyre repair kit.

1. Drive the vehicle for 3 km (2 miles) then stop in a safe place. Carry out a visual examination of the tyre's condition.
2. Remove the protective cap from the inflation hose.
3. Screw the inflation hose connector firmly onto the tyre valve.
4. Read the tyre pressure from the gauge.
5. If the pressure of the sealant filled tyre is above 1.3 bar (19 lbf/in²) adjust the pressure to the correct value.
6. Ensure that the compressor switch is in the off position (O), and insert the power cable connector into an auxiliary power socket.
7. If the vehicle is in a well ventilated area, start the engine.
8. Switch on the compressor (I), and inflate the tyre to the correct pressure.

9. To check the tyre pressure turn off the compressor then read the pressure from the gauge.
10. When the compressor is off, if the tyre pressure is too high, release the required amount of pressure using the pressure relief valve.
11. Once the tyre is inflated to the correct pressure, switch off the compressor and remove the power plug from the auxiliary socket.
12. Unscrew the inflation hose connector from the tyre valve, replace the tyre valve cap and the inflation hose connector protective cap.
13. Do not remove the sealant bottle from the receiver.
14. Ensure that the tyre repair kit (including the bottle, and receiver caps) are placed securely in the vehicle.
15. Drive to the nearest tyre repair centre, or Land Rover Dealer/Authorised Repairer, for a replacement tyre to be fitted. Ensure that you make the repair centre aware that the tyre repair kit has been used before the tyre is removed.
16. Both the tyre inflation hose, and the sealant bottle should be replaced once a new tyre has been fitted.



Only sealant bottles which are completely empty should be disposed of with normal household waste.

Sealant bottles which contain some sealant, and the tyre inflation hose, should be disposed of by a tyre specialist, or your Land Rover Dealer/Authorised Repairer, in compliance with local waste disposal regulations.