

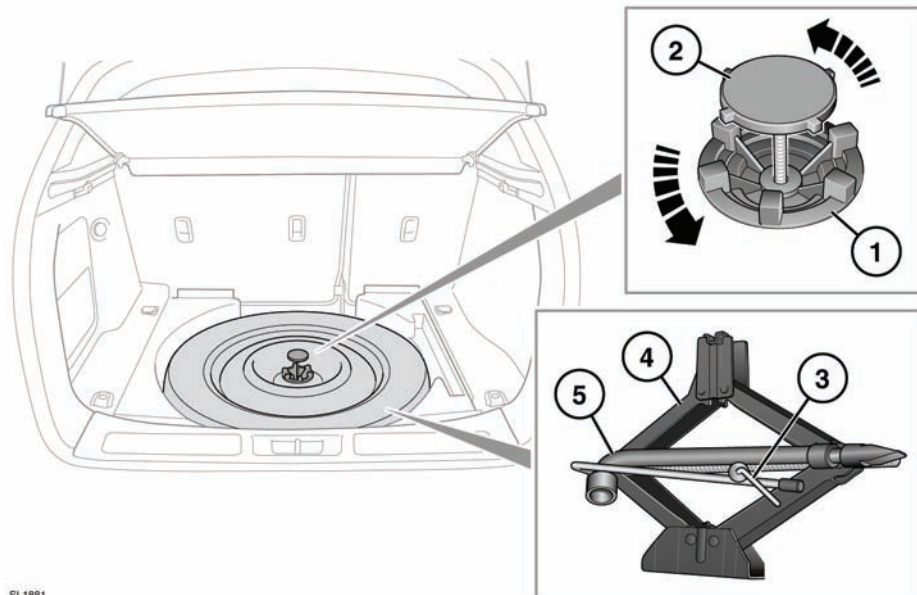

## CHANGING A ROAD WHEEL



SL1881

1. Temporary spare wheel locking ring.
2. Temporary spare wheel retaining bolt.
3. Tool kit retaining bolt.
4. Jack.
5. Wheel brace.

 **After use, the tool kit should be returned to the under floor storage area and correctly stowed.**

 **The spare wheel is heavy and if handled incorrectly may cause injury. Use extreme caution when lifting or manoeuvring the wheels.**

 **Always secure the spare wheel, or the removed wheel, in the correct position using the retaining bolt.**

Always remove the temporary spare wheel before jacking the vehicle.

**Note:** Examine the jack occasionally, clean and grease the moving parts, particularly the screw thread, to prevent corrosion.

## REMOVING THE TEMPORARY SPARE WHEEL







 **Remove the spare wheel prior to jacking the vehicle, to avoid destabilising the vehicle when raised.**

 Do not use power tools to loosen the spare wheel. Doing so may damage the mechanism.

1. To access the temporary spare wheel, fold forward the rear edge of the cover then remove it.
2. Turn the temporary spare wheel locking ring counter clockwise to gain access to the retaining bolt.

3. Turn the retaining bolt counter clockwise until it comes free.
4. Remove the temporary spare wheel.

## TEMPORARY SPARE WHEEL

-  Always adhere to the instructions given on the temporary use spare wheel warning label. Failure to comply can be dangerous.
-  When a temporary use spare wheel is fitted, drive with caution and replace with the specified wheel and tyre as soon as possible.
-  Do not fit more than one temporary use spare wheel and tyre assembly at one time.
-  The temporary use spare wheel must be inflated to 4.2 bar (60 psi, 420 kPa) and cannot be repaired.
-  Temporary use spare wheel, maximum speed is 80 km/h (50 mph).
-  DSC must be switched on while the temporary spare wheel is in use.
-  Traction devices such as snow chains cannot be used with a temporary spare wheel.

## USING WHEEL CHOCKS

**Note:** Wheel chocks are not supplied as part of the tool kit.

Wheel chocks are a useful addition to a vehicle tool kit. Note the following advice when using wheel chocks.









-  Before raising the vehicle, the wheel diagonally opposite the one to be removed must be chocked.

-  Always chock the wheels using suitable wheel chocks. Place the chocks on both sides of the wheel diagonally opposite the wheel to be changed.

-  If jacking the vehicle on a slight slope is unavoidable, place the chocks on the downhill side of both wheels on the axle not being raised.

## WHEEL CHANGING SAFETY

Before raising the vehicle or changing a wheel, ensure that you read and comply with the following warnings.

-  Always find a safe place to stop, off the highway and away from traffic.
-  Ensure that the vehicle and jack are both on firm level ground.
-  Apply the parking brake. Engage Park (P) on automatic vehicles, select 1st or reverse gear on manual vehicles.
-  Switch on the hazard warning lamps.
-  Ensure that the front wheels are in the straight ahead position and engage the steering lock.
-  Disconnect trailer/caravan from vehicle.
-  Ensure that all passengers, and animals, are out of the vehicle and in a safe place away from the highway.
-  Place a warning triangle at a suitable distance behind the vehicle, facing towards oncoming traffic.
-  Never place anything between the jack and the ground, or the jack and the vehicle.

# Wheel changing

 Do not attempt to raise the vehicle unless the jack head is fully engaged in the jacking point. Only jack the vehicle using the approved jacking points.

 Take care when loosening the wheel nuts. The wheel brace may slip off if not properly attached and the wheel nuts may give way suddenly. Either unexpected movement, may cause an injury.

 Take care when lifting the spare wheel and removing the punctured wheel. The wheels are heavy and can cause injuries if not handled correctly.

 Do not start or run the engine while the vehicle is supported only by a jack.

## LOCKING WHEEL NUTS

Locking wheel nuts can be removed only by using the special adapter provided in the tool kit.

**Note:** When the vehicle is first supplied, the adapter may be stored in the glove compartment. It should be removed and stored in the tool kit as soon as possible.

**Note:** A code number is stamped onto the underside of the adapter. If a replacement adapter is required, you will be asked to quote this number. Ensure that the number is recorded and kept safe, but should not be kept with the vehicle.

## RELEASING LOCKING WHEEL NUTS

1. Insert the wheel nut adapter into the locking wheel nut, ensuring that it is fully engaged.
2. Locate the wheel brace over the adapter and unscrew the wheel nut half a turn counter clockwise.

3. After raising the vehicle on the jack, remove the locking wheel nut.

**Note:** After use store the wheel nut adapter correctly in the tool kit.

## WHEEL CHANGING

 **WARNING - THAT NO PERSON SHOULD PLACE ANY PORTION OF THEIR BODY UNDER A VEHICLE THAT IS SUPPORTED BY A JACK.**

 Position the jack from the side of the vehicle, in line with the appropriate jacking point.

 Jack up the vehicle using only the jacking points described, or damage to the vehicle could occur.

**Note:** Your vehicle may be fitted with a tilt sensor which activates the alarm if the vehicle is tilted in any direction after it has been locked. To lock the doors while changing the wheel, and avoid the alarm activating, tilt sensor can be temporarily disabled. See **56, VEHICLE INFORMATION AND SETTINGS MENU**.

Before raising the vehicle, use the wheel nut brace to slacken the wheel nuts half a turn counter clockwise.

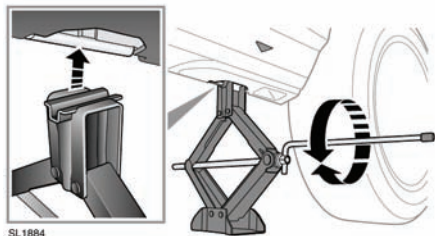
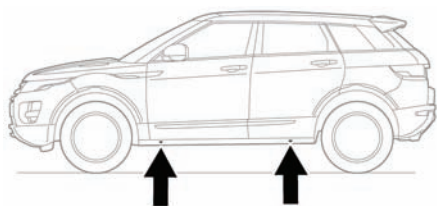

SL1884

1. Locate the jack under the relevant jacking point.  
**Note:** Do not allow the jack to contact the sill at any other point as damage may result.  
**Note:** The Sports pack sills include arrows to identify jacking points.
2. Attach the cranking lever to the jack using the adaptor. Fit the wheel nut brace to the end of the cranking lever.
3. Rotate clockwise to raise until the jack pin locates into the jacking point.
4. Continue raising the vehicle until the wheel is clear of the ground.
5. Remove the wheel nuts and place them together where they cannot roll away.
6. Remove the wheel and place to one side. Do not lay the wheel on its face, as this may damage the finish.
7. Fit the temporary spare wheel to the hub.
8. Re-fit the wheel nuts and lightly tighten them. Ensure that the wheel is making contact with the hub evenly.
9. Ensure that the space under the vehicle is clear of obstructions and lower the vehicle slowly and smoothly.
10. With all wheels on the ground and the jack removed, fully tighten the wheel nuts. The wheel nuts must be tightened in sequence (see illustration) to the correct torque of 133 Nm (98 lb.ft).

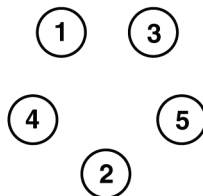

SL1140

**Note:** If it is not possible to torque the wheel nuts when a wheel is replaced, they should be set to the correct torque as soon as possible. Check and adjust the tyre pressure as soon as possible.