

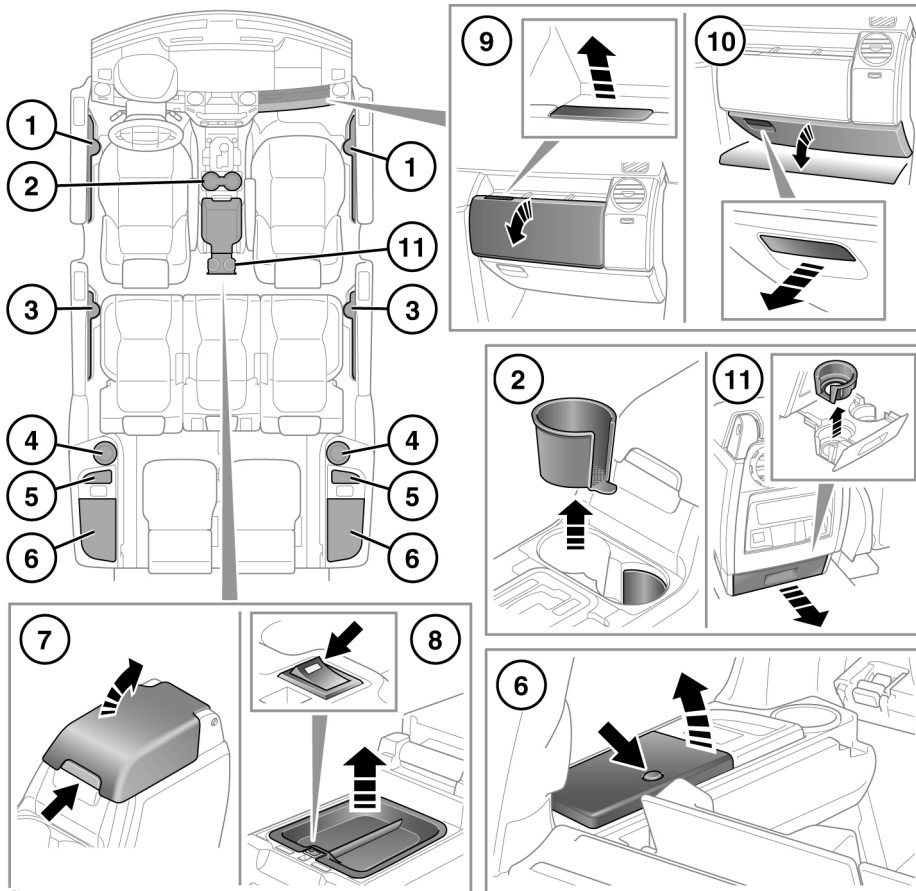

Convenience features

CUP HOLDERS AND STORAGE



SL1067

-  **Ensure that any items stored in the vehicle are secure and cannot move. If the vehicle is involved in an accident, or subject to sudden braking or direction change, loose items can cause serious injury.**
-  **Do not drink, or use the cup holders when driving.**

1. Door bottle holders.
2. Centre console cup holders.
3. Second row seat cup holders.
4. Rear compartment cup holders.
5. Additional storage.
6. Rear storage bins.

7. Centre console storage:
The rubber matt at the bottom of the centre console is designed to hold CD cases.
8. Cool box:
Switch on and off using the switch on the inside front lip. There is a short delay between pressing the switch and illumination of the indicator.
The cool box will work best when the cooling tray is used.
Note: *The cool box will only operate with the ignition turned on.*
 The cool box should be switched off when it is not needed to preserve battery charge.
9. Glovebox.
10. Lower glovebox.
11. Second row seat cup holders.

AUXILIARY POWER SOCKETS

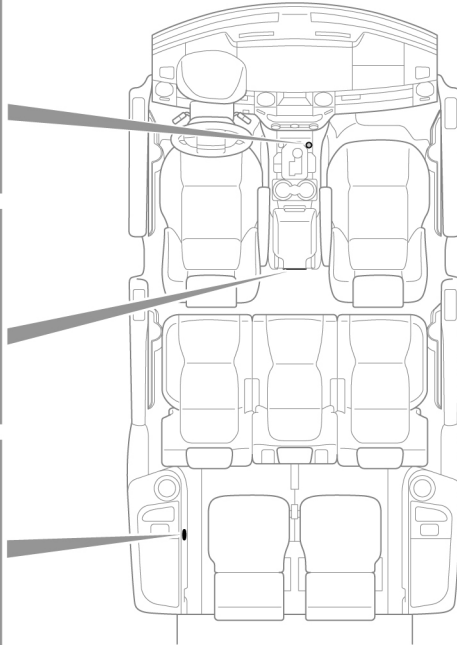
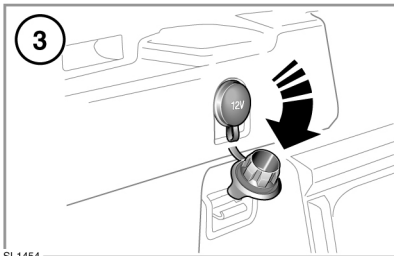
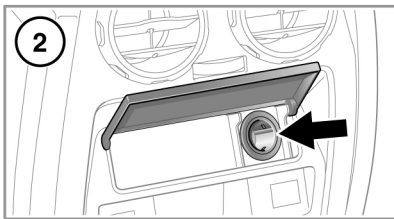
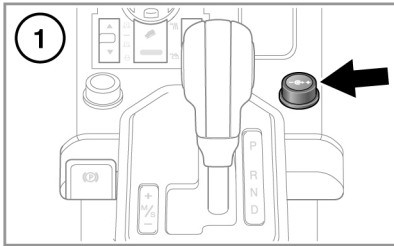

1. Front power socket.
2. Second row power socket.
3. Loadspace power socket.

 Only use Land Rover approved accessories. Using any other equipment may damage the vehicle's electrical system. If you are in any doubt contact a Land Rover Dealer/ Authorised Repairer.

 The engine should be running when using accessories for long periods. Failure to do so can discharge the battery.

Note: Power sockets can be used to power approved accessories that use a maximum of 180 Watts.