

USING SEATBELTS

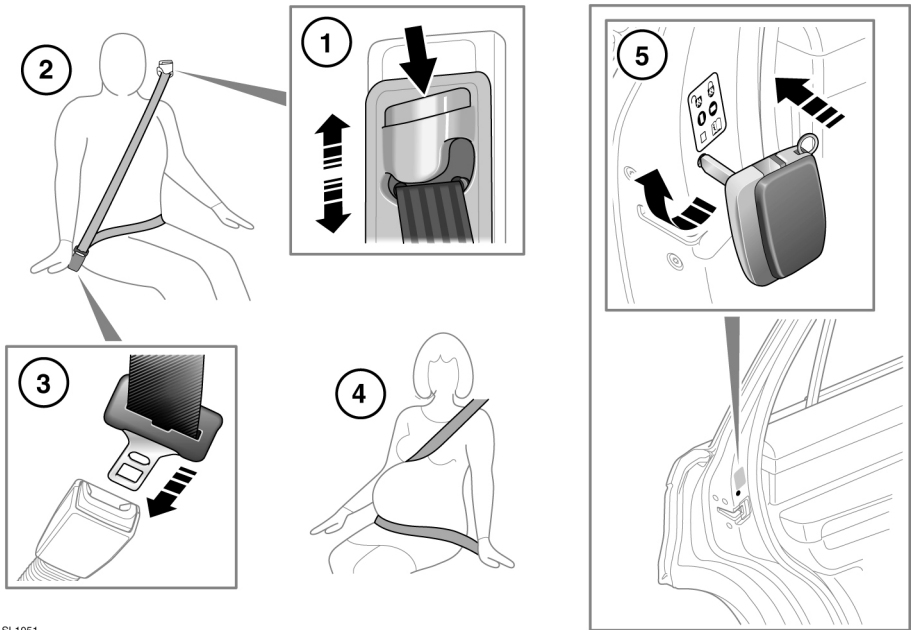

SL1051

1. SEAT BELT HEIGHT ADJUSTMENT:

Press to release the catch.

With the catch depressed move the mechanism slide up or down to the required height. Ensure that the locking mechanism has engaged.

When correctly positioned the seat belt should cross the collar bone at the mid-point between the neck and end of your shoulder.

Where possible, rear seat passengers should adjust their seating position to achieve the same seat belt position.



Ensure that the height is correctly adjusted and the mechanism is locked in place before driving.



The use of comfort clips or devices that would create slack in the seat belt system, is not advised.



WARNING: No modifications or additions should be made by the user which will either prevent the seat belt adjusting devices from operating to remove slack, or prevent the seat belt assembly from being adjusted to remove slack.

2. PUTTING ON A SEAT BELT:

Draw the belt out smoothly, ensure that the belt height, the seat and your position on the seat, are correct.



WARNING: Seat belts are designed to bear upon the bony structure of the body, and should be worn low across the front of the pelvis or the pelvis, chest and shoulders, as applicable; wearing the lap section of the belt across the abdominal area must be avoided.



Seat belts should be adjusted as firmly as possible, consistent with comfort, to provide the protection for which they have been designed. A slack belt will greatly reduce the protection afforded to the wearer.



Belts should not be worn with the straps twisted.



Each belt assembly must only be used by one occupant; it is dangerous to put a belt around a child being carried on the occupant's lap.



The occupants of the front seats should not travel with the seat back at more than 30 degrees from the upright. Doing so will reduce the protection afforded by the seat belt.



Never place anything between you and the seat belt. It can be dangerous and reduce the effectiveness of the seat belt in preventing injury.

3. FASTENING A SEAT BELT:

With the seat belt correctly positioned, place the metal tongue into the buckle nearest to you. Press it in until a click is heard.

To release the seat belt, press the red button.

Note: When releasing the seat belt it is advisable to hold the belt before pressing the release button. This will prevent the belt from retracting too quickly.

4. SEAT BELT USE DURING PREGNANCY:

Position the lap strap comfortably across the hips beneath the abdomen. Place the diagonal part of the seat belt between the breasts and to the side of the abdomen.



Position the seat belt correctly for the safety of the mother and unborn child. Never wear just the lap strap, and never sit on the lap strap whilst using just the shoulder strap. Both of these actions are extremely dangerous, and may increase your risk of serious injury in the event of an accident or during emergency braking.



Never place anything between you and the seat belt in an attempt to cushion the impact in the event of an accident. It can be dangerous, and will reduce the effectiveness of the seat belt in preventing injury.



Ensure that the seat belt is not slack or twisted.

5. CHILD SAFETY LOCKS:

If children are to be carried in the rear seat positions, it is recommended that the rear door interior handles are disabled.

To change the child lock settings:-

- Open the door to access the child safety lock.
- Insert the emergency key into the slot, and rotate a quarter of a turn to enable or disable the interior door handle as required.

SEAT BELT SAFETY



Care should be taken to avoid contamination of the webbing with polishes, oils and chemicals, and particularly battery acid. Cleaning may safely be carried out using mild soap and water.



The belt should be replaced if webbing becomes frayed, contaminated or damaged.



It is essential to replace the entire assembly after it has been worn in a severe impact even if damage to the assembly is not obvious.



If any damage, wear, cuts, defects, or impaired operation are noted with the seat belts, the vehicle should be taken to a Land Rover Dealer/Authorised Repairer for immediate attention. Do not use the vehicle if the seat belts cannot be operated correctly.



Do not carry hard, fragile, or sharp items between your person and the seat belt.



Seat belts should be worn by all vehicle occupants, for every journey no matter how short.



Never wear just the lap belt or just the shoulder belt of a lap/shoulder diagonal seat belt. Both of these actions are extremely dangerous and may increase your risk of injury.



When using seat belts to restrain items other than occupants, take care to ensure that the belts are not damaged, or exposed to sharp edges.

SEAT BELT CHECKS

***Note:** If the vehicle is parked on an incline, the seat belt mechanism may lock. This is not a fault and the belt should be gently eased out from the upper anchorage.*

The seat belts should be inspected regularly to check for fraying, cuts, wear to the webbing and the condition and security of the mechanism, buckles, adjusters and mounting points.

- With the seat belt fastened, give the webbing near the buckle a quick upward pull. The buckle must remain securely locked.
- With the seat belt unfastened, unreel the seat belt to the limit of its travel. Check that it unreels smoothly with no snatches or snags. Allow the belt to fully retract, again checking for smooth operation.
- Partially unreel the seat belt, then hold the tongue plate and give a quick forward pull. The mechanism must lock and prevent any further unreeling.

If any of the seat belts fail to meet those criteria, immediately contact your Land Rover Dealer/Authorised Repairer.

SEAT BELT REMINDER



If the driver's seat belt is not fastened when the vehicle is in motion, a chime will be heard and the seat belt warning lamp will illuminate. The warning chime and warning lamp will also be activated if the front passenger seat is occupied without the seat belt being fastened.

Note: Objects on the front passenger seat may activate the seat belt reminder. It is recommended that any objects placed on the front passenger seat are secured using the seat belt.

CHILD SEATS



For optimum safety, children should travel in the rear of the vehicle at all times; front passenger seat travel is not recommended. However, if it is essential that a child travels in the front (not permitted in Australia), set the vehicle seat fully rearward and seat the child in an approved forward-facing child seat. Do not use a rear-facing child seat - an inflating airbag could impact with the seat and cause serious injury.



Do not use a forward facing child seat until the child using it is above the minimum weight of 9 kg (20 lb.) and able to sit up unaided. Up to the age of two, a child's spine and neck are not sufficiently developed to avoid injury in a frontal impact.



Do not allow a baby or infant to be held or carried on the lap. The force of a crash can increase effective body weight by as much as thirty times, making it impossible to hold onto the child.



Children typically require the use of a booster seat appropriate to their age and size, thereby enabling the seat belts to be properly fitted, reducing the risk of injury in a crash. Children could be endangered in a crash if their child restraints are not properly secured in the vehicle.



Do not use a child seat that hooks over the seat back. This type of seat cannot be satisfactorily secured and is unlikely to be safe for your child.

The seat belts fitted to your vehicle are designed for adults and larger children. For their safety it is very important for all infants and children under 12 years of age to be restrained in a suitable child safety seat appropriate to their age and size.



SL1545

This symbol, affixed to the end of the fascia on the passenger side, warns against the use of a rear-facing child seat in the front passenger seat, when a front passenger airbag is fitted and operational.

If it is essential that a child travels in the front passenger seat (and national legislation permits this), Land Rover recommends that the following preparations are made before fitting the child restraint.

- Disable the front passenger airbag.
- Adjust the front passenger seat fully rearwards.
- Adjust the lumbar support to its minimum support position.
- Adjust the seat cushion to its highest position. If cushion rake adjustment is possible, adjust it to its lowest position.
- Adjust the seat back to the fully upright position.
- Adjust the seat belt adjustable upper anchorage to its lowest position.



Extreme hazard! Do not use a rearward facing child restraint on a seat protected by an airbag in front of it!

CHILD RESTRAINT CHECK LIST

Every time a child travels in the vehicle observe the following:-

- Use appropriate child restraints.
- Carefully follow the restraint system manufacturers instructions.
- Adjust the harnesses for every child on every trip.
- Ensure that all slack is removed from the adult seat belt.
- Always attach the top tether when installing an ISOFIX seat.
- Always check the security of the child restraint.
- Do not dress a child in bulky clothing, or place any objects/padding between the child and the restraint.

- Regularly check the fit and condition of child restraints. If the fit is poor, or wear/damage is visible replace the restraint immediately.
- Set a good example - always wear your seat belt.



WARNING: Child restraint anchorages are designed to withstand only those loads imposed by correctly fitted child restraints. Under no circumstances are they to be used for adult seat belts, harnesses or for attaching other items or equipment to the vehicle.

CHILD SEAT POSITIONING



Information given within the table is correct at the time of going to press. However, availability of child restraints may change. Please consult your Dealer/Authorised Repairer for the latest recommendation.

Note: *The information contained in the following table may not be applicable to all countries. If you are in any doubt regarding the type and fitment of child seats seek advice from your Dealer/Authorised Repairer.*



Crash statistics show that children are safest when properly restrained in a child or infant restraint system that is secured in a rear seating position.

Note: *Ages given are approximate. In case of doubt, the child's weight not age should be used when considering an appropriate child seat.*

Note: *The legislation which governs how and where children should be carried when travelling in a vehicle, is subject to change. It is the responsibility of the driver to comply with all regulations in force.*

Occupant safety

Mass group.	0 = Up to 10 kg (22 lb) 0-9 months	0+ = Up to 13 kg (29 lb) 0-18 months	I = 9-18 kg (20-40 lb) 9 months to 4 years	II = 15-25 kg (33-55 lb) 4-9 years	III = 25-36 kg (55-80 lb) 8-12 years
Seating positions					
Front passenger*	U	U	U	U	U
Rear seats (5 seat vehicle)	L	L	L	L	L
Second row seats (7 seat vehicle)	U	U	U	U	U
Third row seats	X	X	UF	UF	UF

- U = Suitable for universal category restraints approved for this mass group.
- UF = Suitable for Forward-facing universal category restraints approved for this mass group.
- X = not suitable for children in this mass group.
- L = suitable for particular child restraints as listed in the Child seat usage table (see below).

* Always ensure that the passenger airbag has been disabled before using a child restraint in this seating position. The seat back needs to be adjusted to the fully upright position.

RECOMMENDED CHILD SEATS

Child size/age	Recommended seat
Groups 0 and 0+	Britax/Römer Baby Safe Plus
Group I	Britax/Römer Duo Plus
Group II and III	Britax/Römer Kid Plus

ISOFIX ANCHOR POINTS (not Australia)

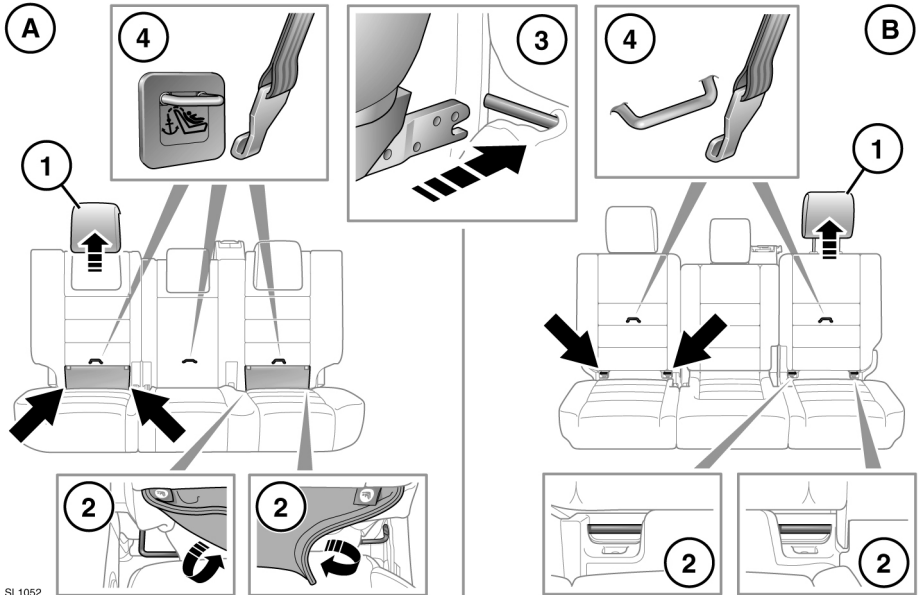

SL1052

A. 5-Seat vehicles.

B. 7-Seat vehicles.

Both of the outer seat positions on the rear seat are equipped to accept ISOFIX restraints.



This symbol is shown on a label sewn into the seats to indicate the position of the ISOFIX lower anchorages. To install an ISOFIX child seat:-

1. Raise or remove the head restraint.
2. Lift the velcro flap to expose the ISOFIX locking mechanism.
3. Slide the child seat into the locking mechanism.

Note: Always ensure that if an upper tether is provided, it is fitted and tightened correctly.

Note: ISOFIX child restraints are only fitted to the second row of seats.

Test the security of the child restraint. To do this, attempt to pull the restraint away from the vehicle seat and twist the restraint from side to side. Even if the restraint appears secure, you should still check the anchor points visually, to ensure correct attachment.



Do not attempt to fit ISOFIX restraints to the centre rear seating position. The anchor bars are not designed to hold an ISOFIX restraint in this position.



If the restraint is not correctly anchored, there is a significant risk of injury to the child in the event of a collision or emergency braking.

Note: Always refit a removed head restraint after the child restraint is removed. See **21, REAR HEAD RESTRAINTS**

ISOFIX CHILD SEAT POSITIONS

Mass group as shown on child restraint	Size classes	Fixtures	Vehicle ISOFIX positions
Carrycot	F/G	ISO L1/L2	X
0 = Up to 10 kg (22 lb) 0-9 months	E	ISO R1	IL*
0+ = Up to 13 kg (29 lb) 0-18 months	C/D/E	ISO R1/R2/R3	IL*
I = 9 to 18 kg (20 to 40 lb) 9 months - 4 years	C/D A/B1/B	ISO R2/R3 ISO F2/F2X/F3	X IUF
II = 15 to 25 kg (33 to 55 lb) 4-9 years	N/A	N/A	N/A
III = 22 to 36 kg (49 to 80 lb) 8-12 years	N/A	N/A	N/A

- IUF = Suitable for ISOFIX forward child restraint systems of universal category approved for use in the mass group.
- IL = These ISOFIX child restraint systems are of the specific vehicle, restricted or semi-universal categories.
- X = Not suitable for ISOFIX child restraint fitment in this mass group.
- * = Child seat suitable for use in these locations, is the Britax/Römer Baby Safe Plus ISOFIX.

Note: Ages given are approximate. In case of doubt, the child's weight not age should be used when considering an appropriate child seat.

Note: The information contained in the table may not be applicable to all countries. If you are in any doubt regarding the type and fitment of child seats seek advice from your Dealer/ Authorised Repairer.

Note: ISOFIX anchorages are provided for second row outer seating positions. ISOFIX child restraints should be securely attached following the manufacturers instructions at these locations only.

TETHER ANCHORAGE POINTS (Australia only)

Your vehicle is equipped with anchorage points on the back of the second row seat frames. These should be used to attach straps from child seats or restraint systems.

Note: A tether anchorage is provided for the centre seat position. Do not use this anchor position with an ISOFIX child seat.

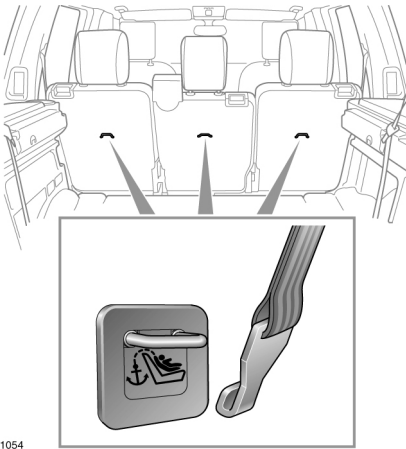

SL1054



WARNING: Child restraint anchorages are designed to withstand only those loads imposed by correctly fitted child restraints. Under no circumstances are they to be used for adult seat belts, harnesses or for attaching other items or equipment to the vehicle.



Always follow the child seat or restraint system manufacturer's instructions when fitting tether straps.



When fitting a child seat or restraint system, always pass the tether strap over the top of the seat back and beneath the head restraint.



If a child seat or restraint system is to be fitted to the centre seating position, the centre armrest must be in the stowed position (folded into the seat).

ATTACHING TETHER STRAPS

1. Install the child restraint securely in one of the rear seating positions.
2. Pass the tether strap over the seat back and beneath the head restraint.
3. Attach the tether strap hook to the tether anchor point on the back of the seat. Ensure that the tether strap hook is facing the correct way (see illustration).
4. Tighten the tether strap according to the manufacturer's instructions.

BOOSTER CUSHIONS

In a situation where a child is too large to fit into a child safety seat but is still too small to safely use just the three point belt, a booster seat is recommended for maximum safety. Follow the manufacturer's instructions for fitting and use, then adjust the seat belt to suit.

AIRBAG SUPPLEMENTARY RESTRAINT SYSTEM (SRS)

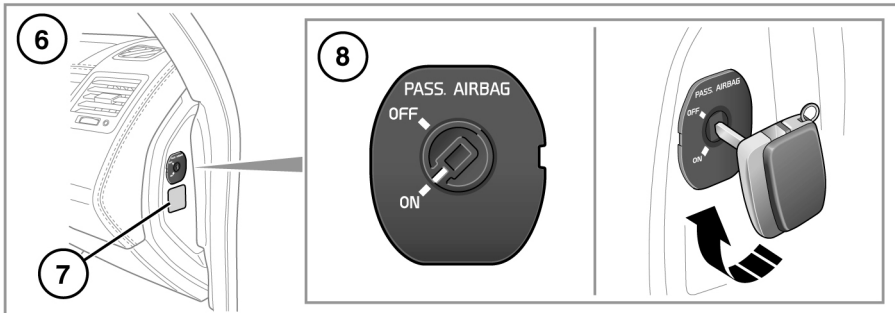
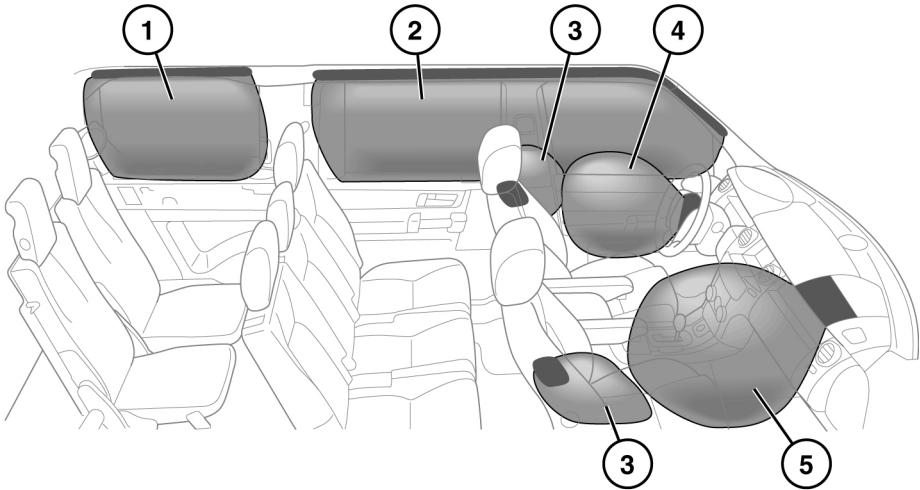

SL1056

1. 3rd row seats, curtain airbag
2. Main curtain airbag.
3. Side airbags.
4. Driver's front and side airbags.
5. Passenger front and side airbags.
6. Passenger airbag disable switch location
7. Passenger airbag warning label
8. Passenger airbag disable switch operation.

Note: The general location of airbags fitted to the vehicle are marked by the word AIRBAG.

Always contact your Dealer/Authorised repairer if:

- An airbag inflates.
- The front or sides of the vehicle are damaged.
- Any part of the Airbag Supplementary Restraint System (SRS) shows signs of cracking or damage, including trim covering airbags.

AIRBAG OPERATION



For the airbags to operate correctly the roof lining and door post trims must be in good condition, correctly fitted, and free from obstruction. Any damage, wear, or incorrect fitment should be referred to your Dealer/ Authorised Repairer as soon as possible for examination and repair.



Do not allow passengers to obstruct the operation of the airbags by placing any part of their person, or any objects, in contact with, or close to, an airbag module. Only use approved accessories (e.g. seat covers).



Ensure that a gap is maintained between the side of the vehicle, and the head and torso. This will enable unobstructed inflation of the curtain, and seat mounted side airbags.



Airbags inflate at high speeds. To minimise the risk of injury, ensure that all vehicle occupants wear correctly positioned seat belts, sit correctly in the seats, and position the seats as far back as practical.



Airbag inflation takes place instantaneously, and cannot protect against the effects of secondary impacts. Under these circumstances the only protection will be provided by a correctly worn seat belt.



Phone systems should only be installed by qualified persons familiar with the operation of, and requirements for, vehicles fitted with SRS. If you are in any doubt, seek advice from your Dealer/Authorised repairer.

Airbag deployment is dependent on the rate at which the passenger compartment changes velocity following the collision. Circumstances affecting different collisions (vehicle speed, angle of impact, type and size of object hit, etc.), vary considerably and will affect the rate of deceleration accordingly.

Airbags cannot deploy correctly if they are obstructed. Examples of obstructions are:-

- Any part of an occupants body in contact with, or close to, an airbag cover.
- Objects placed on, or close to, an airbag cover.
- Clothing, sun screens, or other material hanging from grab handles.
- Clothing, cushions, or other material, covering seat mounted airbags.
- Seat covers which are not approved by Land Rover, or specifically designed for use with seat mounted airbags.

This list is not exhaustive, and it remains the responsibility of the driver and passengers to ensure that the airbags are not obstructed in any way.

Note: *The airbags and SRS are not designed to operate as a result of:*

- Rear impacts.
- Minor front impacts.
- Minor side impacts.
- Heavy braking.
- Driving over bumps and pot holes.





High speed impacts may cause serious injury or death irrespective of safety features fitted to a vehicle.



The airbag SRS cannot provide protection in some types of impact. Under these circumstances the only protection will be provided by a correctly worn seat belt.

DISABLING THE PASSENGER AIRBAG

Note: The passenger airbag should be disabled only when a rearward facing child restraint is fitted to the front passenger seat.

-  **Crash test data and statistics show that the safest place for a child to be restrained is in a child seat correctly fitted to the vehicle's rear seat.**
-  **Do not use a child restraint on a seat protected by an operational airbag in front of it. Doing so presents a high risk of death or serious injury to the child in the event of an accident.**
-  **Do not fit a child restraint to the front passenger seat if the SRS warning light illuminates continuously with the ignition on.**

To disable the passenger airbag:-

1. Remove the emergency key from the Smart Key.
2. Insert the end of the key blade into the slot in the switch and rotate the switch to the off position (refer to **32, AIRBAG SUPPLEMENTARY RESTRAINT SYSTEM (SRS)**, item **8**).

-  **As soon as the child seat is removed from the front passenger seat, the airbag must be turned on. Failure to do so will put any front seat passengers at greater risk of death or serious injury in the event of an accident.**

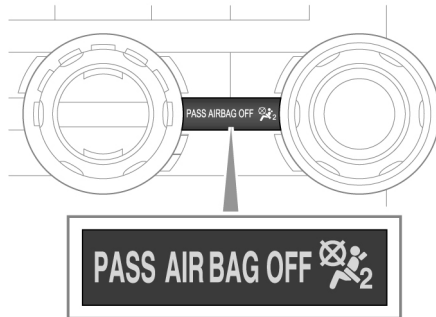

SL1058

-  **When checking the operational status of the front passenger airbag, ensure that the ignition is switched on.**

The passenger airbag operational status indicator illuminates yellow when the airbag has been disabled.

Note: The indicator will only illuminate when the ignition is turned on or the engine is running.

FRONT AIRBAGS

The front passenger and driver airbags are able to deploy in two stages, depending on the severity of the frontal impact. In a severe impact, the airbags inflate fully to offer maximum protection. In a lesser impact, full deployment is not required, so the airbags are partially inflated.

SIDE AND CURTAIN AIRBAGS

Note: *Curtain airbags are not fitted to the commercial variant.*

Side and curtain airbags are designed to offer increased protection for the torso and head in a side impact. The curtain airbags deflate at a slower rate than the front or side airbags, to afford greater protection from serious head injuries.

AIRBAG DEPLOYMENT EFFECTS



When an airbag inflates, a fine powder is released. This is normal and not an indication of a malfunction. The powder may cause irritation to the skin and should be thoroughly flushed from eyes and any cuts or abrasions.



Airbag deployment is accompanied by a very loud noise which may cause discomfort and temporary loss of hearing.

AIRBAG WARNING LAMP



The airbag warning lamp is mounted in the instrument pack, and will illuminate as a bulb check when the ignition is turned on.



If the warning lamp indicates that a fault is present in the system, do not use a child restraint on the front passenger seat.

If any of the following warning lamp conditions occur, the vehicle should be checked by your Dealer/Authorised Repairer immediately.

- The warning lamp fails to illuminate when the ignition is turned on.
- The warning lamp fails to extinguish within 6 seconds of the ignition being turned on.

- The warning lamp illuminates at any time other than the bulb check, when the ignition is turned on.

AIRBAG SERVICE INFORMATION



Do not attempt to service, repair, replace, modify, or tamper with, any part of the SRS. This includes wiring or components in the vicinity of SRS components. Doing so may cause the system to trigger, or render the system inoperative.



Do not use any electrical test equipment or devices in the vicinity of SRS components or wiring. Doing so may cause the system to trigger, or render the system inoperative.

All of the following operations should only be carried out by a Dealer/Authorised Repairer, or suitably qualified person:-

- Removal or repair of any wiring or component in the vicinity of any SRS components.
- Installation of electrical, or electronic, equipment and accessories.
- Modification to the front or sides of the vehicle exterior.
- Attachment of accessories to the front or sides of the vehicle.