

Front seats

ELECTRIC SEATS

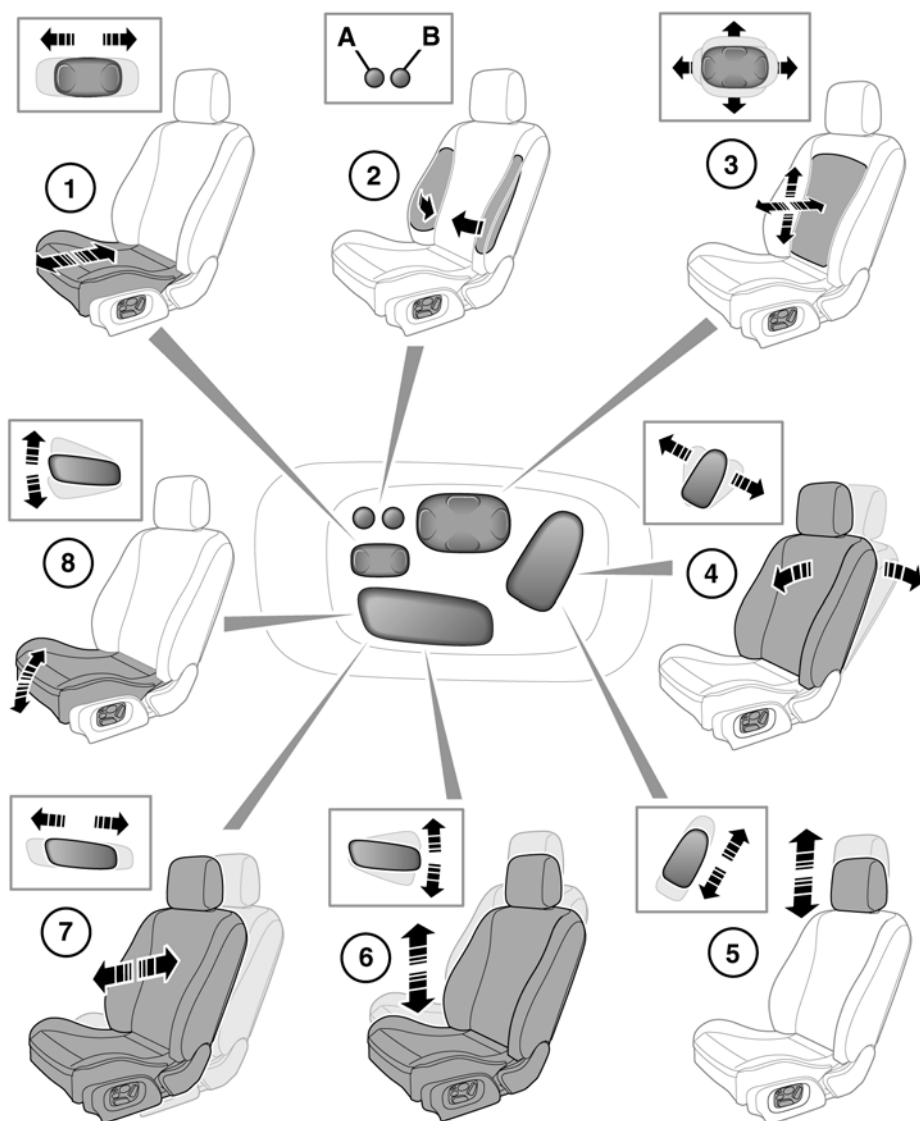

SJ1004

1. Cushion length adjustment.
2. Bolster adjustment:
 - A. Bolster inflate.
 - B. Bolster deflate.
3. Lumbar support adjustment.
4. Seat back angle adjustment.
5. Head restraint height adjustment.
6. Height adjustment.
7. Fore and aft adjustment.
8. Cushion front tilt adjustment.

To adjust the seats, the Jaguar Smart Key must be in the vehicle and the ignition turned on.

DRIVING POSITION MEMORY

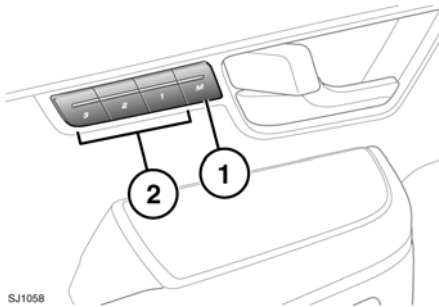

1. Memory set button.
2. Memory presets.

Once you have adjusted the driver's seat, steering column (see **16, ADJUSTING THE STEERING WHEEL**) and exterior mirrors (see **36, EXTERIOR MIRRORS**) the vehicle can memorise these settings using the driver memory buttons.

Once the passenger seat has been adjusted, these settings can be memorised using the passenger memory buttons.

1. Press the memory set button to activate the memory function.
2. Press one of the preset buttons within five seconds to memorise the current settings. For the driver's settings, **MEMORY 1 (2 or 3) SETTINGS SAVED** will be displayed on the message centre accompanied by an audible chime to confirm the settings have been memorised.

A seat position can only be memorised during the five second period.

Any existing settings for a memory preset will be over-written when programming a memory position.

RECALLING A MEMORISED POSITION

Press the appropriate memory preset button (for the driver's settings, **MEMORY 1 (2 or 3) SETTINGS RECALLED** will be displayed in the message centre).

RESTRICTED SEAT TRAVEL

If an obstruction is encountered while the seat is in motion, the seat will stop moving and further movement will be restricted until reset.



To reset the seat:

1. Remove the obstruction.
2. Adjust the seat to the point where movement is restricted.
3. Press and hold the switch for at least 2 seconds to override the restriction.

Front seats

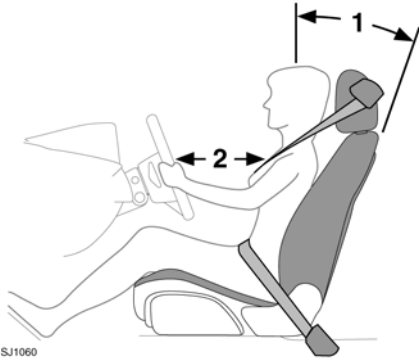
SITTING IN THE CORRECT POSITION





-  **The driver and front passenger must not ride with the seat fully reclined.**
-  **Do not adjust the seat while the vehicle is moving.**

The seat, head restraint, seat belt and airbags, all contribute to the protection of the user. Correct use of these components will give you greater protection, therefore you should observe the following points:

1. Sit in an upright position with the base of your spine as far back as possible and the seat back reclined no more than 30 degrees, to achieve optimum benefit of the seat belt in the event of an accident.
 2. Do not move the driver's seat too close to the steering wheel. Ideally, a minimum distance of 254 mm (10 inches) is recommended between the breastbone and the steering wheel airbag cover. Hold the steering wheel in the correct position with your arms slightly bent.
- Adjust the head restraint so that the top of the head restraint is above the centre line of the head.

- Position the seat belt so that it is mid-way between your neck and your shoulder. Fit the strap tightly across your hips, not across your stomach.
- Ensure that your driving position is comfortable and enables you to maintain full control of the vehicle.

HEAD RESTRAINTS

-  **Adjust the head restraint so that the top of the head restraint is above the centre line of the head. An incorrectly adjusted head restraint increases the risk of death or serious injury in the event of a collision.**
-  **It is possible to swivel the head restraint forwards or backwards. For greater protection in the event of a collision, the head restraint should be adjusted so that it is as close to the back of the head as is practical.**
-  **Never adjust the head restraints while the vehicle is in motion.**

To adjust the angle of the head restraint, press the locking button on the side of the restraint and tilt to the desired position. Release the button to lock in place.

Note: *It is not possible to remove the front head restraints.*