

ENGINE OIL - 2.7 DIESEL AND V6 PETROL ENGINES

- ⚠ Check the engine oil weekly. If any significant or sudden drop in oil level is noted, seek qualified assistance.

Check the oil level when the engine is cold and with the vehicle resting on level ground.

Note: *If it is necessary to check the oil level when the engine is hot, switch off the engine and let the vehicle stand for 5 minutes to allow the oil to drain back into the sump. Do not start the engine.*

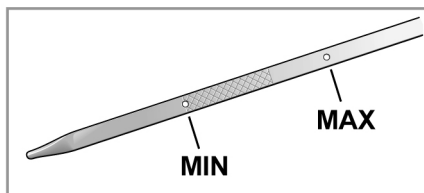
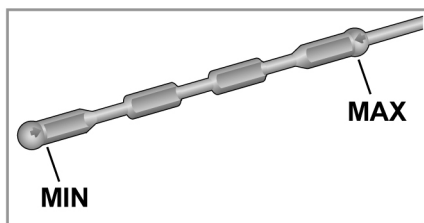

SL1298

1. Withdraw the dipstick and wipe the blade clean with a lint free cloth.
2. Fully re-insert the dipstick and withdraw again to check the oil level. Never allow the oil level to fall below the lower mark or notch on the dipstick.

As a general guide, if the level on the dipstick:

- Is nearer to the upper mark or notch than the lower, add no oil.
- Is nearer to the lower mark or notch than the upper, add half a litre (one pint) of oil.

- Is below the lower mark or notch, add 1 litre (2 pints) of oil and re-check the level after a further 5 minutes.

ENGINE OIL - 3.0 DIESEL AND V8 PETROL ENGINES

- ⚠ Check the engine oil weekly. If any significant or sudden drop in oil level is noted, seek qualified assistance.
- ⚠ If the message **ENGINE OIL PRESSURE LOW** is displayed, stop the engine as soon as it is safe to do so and seek qualified assistance. Do not start the engine until the cause has been rectified.

Prior to checking the oil level ensure that:

- The vehicle is on level ground.
- The engine oil has reached working temperature (oil is hot).
- The engine has been switched off for 10 minutes, as the system will not give an accurate reading until the oil level has stabilised.

The oil level can then be checked as follows:

1. Switch on the ignition (do not start the engine).
2. Ensure Park (**P**) is selected.
3. Select the **Service** menu using the driver information module menu control (see **58, VEHICLE INFORMATION AND SETTINGS MENU**).

Select **Oil level display** from the Service menu. The current oil level status and topping-up advice is displayed in the instrument panel, top-up as instructed.

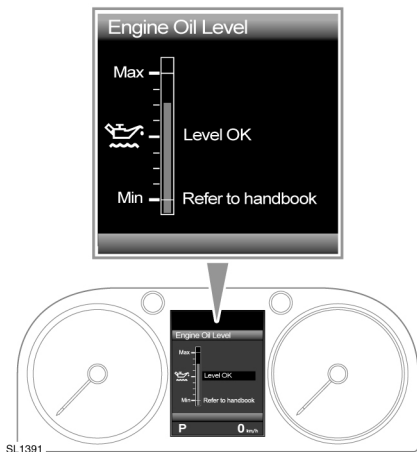

An indication of the oil level is displayed in the gauge. Messages to the right of the gauge advise you of any action you may need to take.

If the oil level is within the required operating range, the message **Engine Oil Level OK** will be displayed. Do not add any additional oil to the engine.

If the oil level is below the required operating range, a message advising you how much oil to add will be displayed (e.g. **Add 0.5 Litre**). Add the recommended quantity of oil.

If the message **Engine Oil Level Overfilled** is displayed, seek qualified assistance immediately. Do not drive the vehicle as this will cause serious damage to the engine.

If the message **Engine Oil Level Underfilled** is displayed, add 1.5 litres (2.6 pints) of oil, then recheck the level.

If the message **Engine Oil Level Not Available** is displayed, the oil level is stabilising. Switch off the ignition, wait 10 minutes, then recheck the oil level display.

If the warning message **ENGINE OIL LEVEL MONITOR SYSTEM FAULT** is displayed, seek qualified assistance.

TOPPING UP THE OIL

- ⚠ Your vehicle warranty may be invalidated if damage is caused by using oil that does not meet the required specification.
 - ⚠ Failure to use an oil that meets the required specification could cause excessive engine wear, a build up of sludge and deposits, and increase pollution. It could also lead to engine failure.
 - ⚠ Overfilling with oil could result in severe engine damage. Oil should be added in small quantities and the level re-checked to ensure that the engine is not overfilled.
1. Remove the oil filler cap.
 2. Add oil as instructed by the dipstick display (3.0 Diesel and V8 Petrol engines) or to maintain the level between the **MIN** and **MAX** marks or notches on the dipstick (2.7 Diesel and V6 Petrol engines).
 3. Clean up any oil spilled during topping-up.
 4. Check the oil level again after 10 minutes (3.0 Diesel and V8 Petrol engines) or after 5 minutes (2.7 Diesel and V6 Petrol engines).

It is essential to use the correct specification oil, and to ensure it is suitable for the climatic conditions in which the vehicle is to be operated.

Note: *The approximate quantity of oil required to raise the level from **MIN** to **MAX** on the dipstick is 1.5 litres (2.6 pints) for all models.*

ENGINE OIL SPECIFICATION

Model	Specification
V6 Petrol engine	Use only SAE 5W-30 engine oil, meeting WSS-M2C913-C specification only.
V8 Petrol engine	Use only 5W-20 oil meeting specification WSS-M2C925-A only.
Diesel engines	Use only 5W-30 oil meeting specification WSS-M2C934-B.

Land Rover recommends Castrol oils.

CHECKING THE COOLANT LEVEL

! Running the engine without coolant will cause serious engine damage.

The coolant level in the expansion tank should be checked at least weekly (more frequently in high mileage or arduous operating conditions). Always check the level when the system is cold.

Ensure the coolant level remains between the COLD FILL RANGE indicator marks located on the side of the expansion tank. Ignore any coolant visible in the top section of the tank

If the level has dropped suddenly, or by a large amount, arrange for the vehicle to be examined by a qualified technician as soon as possible.

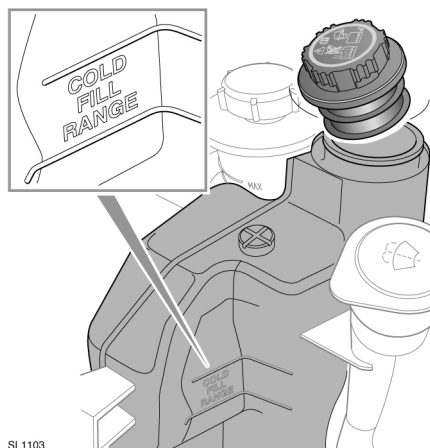

SL1103

TOPPING UP THE COOLANT

- !** Never remove the filler cap when the engine is hot - escaping steam or scalding water could cause serious personal injury.
- !** Avoid spilling antifreeze onto a hot engine - a fire may result.
- !** Unscrew the filler cap slowly, allowing the pressure to escape before removing completely.
- !** When travelling in territories where the water supply contains salt, always ensure you carry a supply of fresh (rain or distilled) water. Topping up with salt water will cause serious engine damage.

Top-up to the upper level indicator mark of the COLD FILL RANGE located on the side of the expansion tank. Use only a 50% mix of water and Castrol SF antifreeze.

Note: In an emergency - and only if the approved antifreeze is unavailable - top-up the cooling system with clean water, but be aware of the resultant reduction in frost protection. Do not top-up or refill with conventional antifreeze formulations. If in doubt consult a qualified technician.

Ensure the cap is tightened fully after top-up is completed by turning the cap until the ratchet cap clicks.

ANTIFREEZE



Antifreeze is poisonous and can be fatal if swallowed - keep containers sealed and out of the reach of children. If accidental consumption is suspected, seek medical attention immediately.



If the fluid comes into contact with the skin or eyes, rinse immediately with plenty of water.



The use of non-approved antifreeze will have an adverse effect on the engine cooling system and therefore engine durability.



Antifreeze will damage painted surfaces; soak up any spillage with an absorbent cloth immediately and wash the area with a mixture of car shampoo and water.

Antifreeze contains important corrosion inhibitors. The antifreeze content of the coolant must be maintained at 50% ± 5% all year round (not just in cold conditions). To ensure that the anti-corrosion properties of the coolant are retained, the antifreeze content should be checked once a year and completely renewed every ten years, regardless of distance travelled. Failure to do so may cause corrosion of the radiator and engine components.

The specific gravity of a 50% antifreeze solution at 20°C (68°F) is 1.068 and protects against frost down to -40°C (-40°F).

BRAKE/CLUTCH FLUID CHECK



Brake fluid is highly toxic - keep containers sealed and out of the reach of children. If accidental consumption of fluid is suspected, seek medical attention immediately.



If the fluid comes into contact with the skin or eyes, rinse immediately with plenty of water.



Take care not to spill the fluid onto a hot engine - a fire may result.



Do not drive the vehicle with the fluid level below the MIN mark.



Seek qualified assistance immediately if brake pedal travel is unusually long or if there is any significant loss of brake fluid. Driving under such conditions could result in extended stopping distances or complete brake failure.



If the quantity of fluid in the brake/clutch reservoir drops below the recommended level, a red warning lamp in the instrument pack will illuminate.

Note: If the warning lamp illuminates while the vehicle is being driven, stop the vehicle as soon as safety permits by gently applying the brakes. Check and top-up the fluid level if necessary.

With the vehicle on level ground, check the fluid level at least every week (more frequently in high mileage or arduous operating conditions).

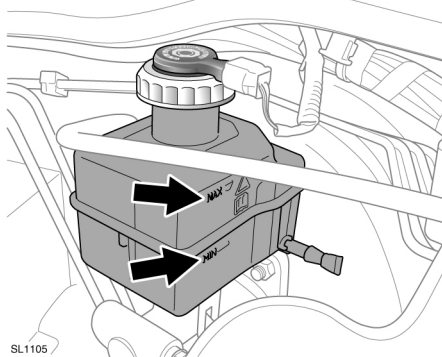
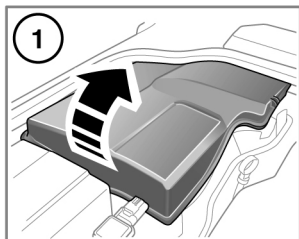

SL1105

The left hand or right hand under bonnet cover must be removed to check the brake fluid level, dependent on the vehicle being left-hand drive (left hand cover) or right-hand drive. See **186, UNDER BONNET COVERS - REMOVAL.**

Look at the fluid level through the side of the transparent reservoir without removing the filler cap.

The brake fluid must be between the **MAX** and **MIN** marks.

TOPPING UP THE FLUID

- ⚠ Brake fluid will damage painted surfaces. Soak up any spillage with an absorbent cloth immediately and wash the area with a mixture of car shampoo and water.
- ⚠ Only use new fluid from an airtight container (fluid from opened containers or fluid previously bled from the system will have absorbed moisture, which will adversely affect performance, and must not be used).

1. Clean the filler cap before removing to prevent dirt from entering the reservoir.
2. Remove the filler cap.
3. Top-up the reservoir to the **MAX** mark using Shell DOT4 ESL brake fluid. If Shell DOT4 ESL is not available, a low viscosity DOT4 brake fluid that meets ISO 4925 class 6 and Land Rover LRES22BF03 requirements may be used.
4. Replace the cap and reservoir cover.

POWER STEERING FLUID CHECK



Power steering fluid is highly toxic. Keep containers sealed and out of reach of children. If accidental consumption of fluid is suspected, seek medical attention immediately.



If the fluid comes into contact with the skin or eyes, rinse immediately with plenty of water.



Do not start the engine if the fluid level has dropped below the **MIN** mark. Severe damage to the steering pump could result.



Seek qualified assistance immediately if there is a noticeable drop in the fluid level. Severe damage to the steering pump could result.



If fluid loss is slow, the reservoir may be topped-up to the upper level mark to enable the vehicle to be driven to a repair facility for examination. However, it is recommended that you seek qualified assistance before driving the vehicle.

Check and top-up the fluid with the vehicle on level ground, engine switched off, and the system cold. Ensure that the steering wheel is not turned after stopping the engine.

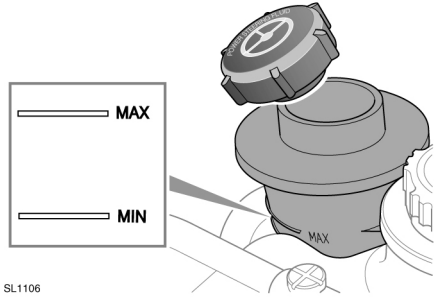

SL1106

The level of fluid can be seen through the translucent body of the reservoir.

The fluid level should be between the **MIN** and the **MAX** marks.

TOPPING UP THE FLUID



Power steering fluid will damage painted surfaces. Soak up any spillage with an absorbent cloth immediately and wash the area with a mixture of car shampoo and water.



Do not fill the reservoir above the **MAX** mark.

1. Clean the filler cap before removing to prevent dirt from entering the reservoir.
2. Remove filler cap.
3. Using Texaco cold climate PAS fluid, top up the reservoir until the fluid level is between the **MIN** and **MAX** marks.
4. Replace filler cap.

WASHER FLUID CHECK



Some screen washer products are inflammable, particularly if high or undiluted concentrations are exposed to sparking. Do not allow screen washer fluid to come into contact with naked flames or sources of ignition.



If the vehicle is operated in temperatures below 4°C (40°F), use a washer fluid with frost protection. In cold weather, failure to use a washer fluid with frost protection, could result in impaired vision and increase the risk of a vehicle crash.



Do not use an antifreeze or vinegar/water solution in the washer reservoir - antifreeze will damage painted surfaces, while vinegar can damage the windscreen washer pump.



Body panels may suffer discolouration as a result of screen washer fluid spillage. Take care to avoid spillage, particularly if an undiluted or high concentration is being used. If spillage occurs, wash the affected area immediately with water.

TOPPING UP THE FLUID

The washer reservoir supplies both front and rear screen washer jets and headlamp washer jets.

Check and top-up the reservoir level at least every week. Always top-up with screen washer fluid to prevent freezing.

Operate the washer switches periodically to check that the nozzles are clear and properly directed.

1. Clean the filler cap before removing to prevent dirt from entering the reservoir.
2. Remove filler cap.
3. Top-up the reservoir until the fluid is visible in the filler neck.
4. Replace filler cap.