

DISCOVERY SPORT

QUICK START GUIDE

- 2 DRIVER CONTROLS
- 3 VEHICLE ACCESS
- 4 COMFORT ADJUSTMENTS
- 6 DRIVING
- 11 TOUCH SCREEN
- 12 MEDIA
- 14 NAVIGATION
- 15 PHONE
- 16 FILLING STATION INFORMATION

SOME OF THE FEATURES DESCRIBED MAY NOT BE FITTED TO YOUR VEHICLE.



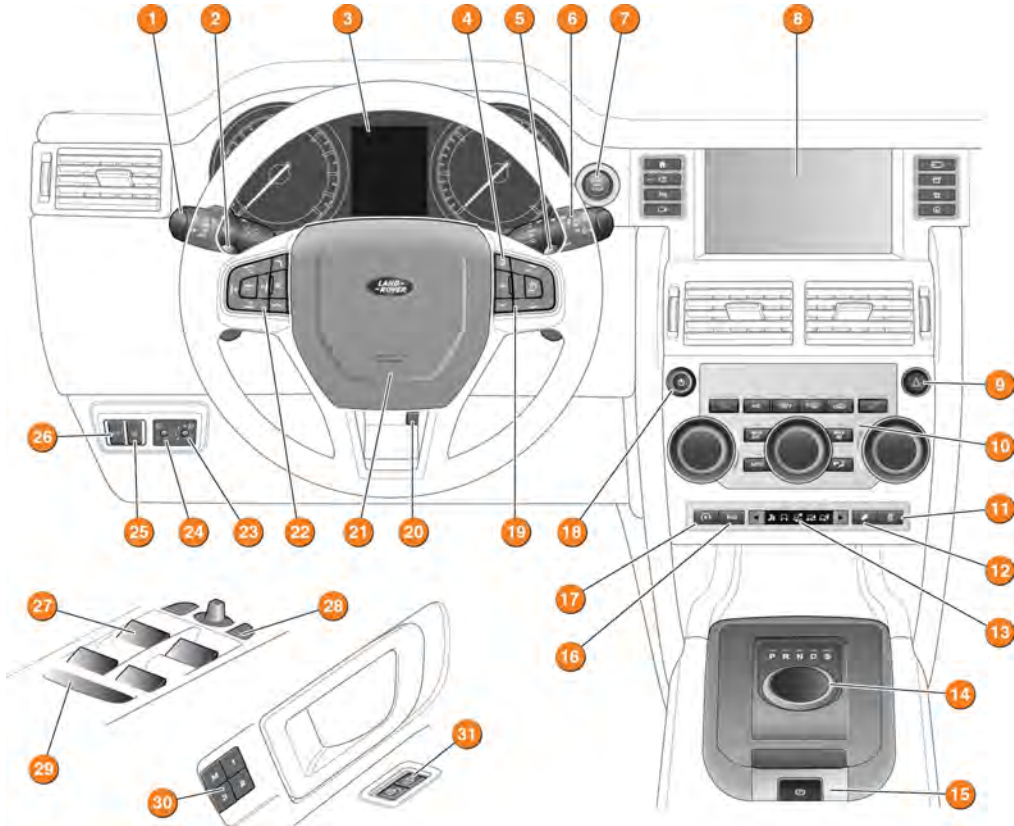

1. Headlamps, direction indicators and trip computer.
2. Gearshift paddle - for down shifts.
3. Instrument panel, warning lamps and Message centre.
4. Heated steering wheel.
5. Gearshift paddle - for up shifts.
6. Wipers and washers.
7. Engine START/STOP.
8. Touch screen.
9. Hazard warning lamps.
10. Climate control.
11. Stability control.
12. Hill descent control.
13. Terrain response.
14. Gear selector.
15. Electric parking brake.
16. ECO program.
17. Intelligent stop/start.
18. Audio on/off and volume.
19. Cruise control or Adaptive cruise control switches.
20. Steering wheel adjuster.
21. Horn.
22. Telephone and voice recognition controls and instrument panel menu control.
23. Headlamp levelling control.
24. Interior lamps dimming control.
25. Lane departure warning button.
26. Tailgate release.
27. Window controls.
28. Mirror adjuster/power fold mirror.
29. Rear windows isolation.
30. Driving position memory.
31. Central locking switches.

Smart key



Press once to switch the approach lamps on. Press again to switch off.



Press to unlock and release the tailgate. A powered tailgate opens to the set height. If the alarm is armed, it is inhibited while the tailgate is open.



Press and hold for 3 seconds to activate the panic alarm. After 5 seconds, press again for 3 seconds to cancel.

Unlocking mode alternatives



Single-point entry. Press once to unlock only the driver's door and the fuel filler flap. Press twice to unlock all of the doors, the fuel filler flap and the tailgate.

Multi-point entry. Press once to unlock all of the doors, the fuel filler flap and the tailgate.

To change the mode - with the vehicle unlocked, press and hold the lock and unlock buttons simultaneously for 3 seconds. The hazard warning lamps flash to confirm the change.

Keyless entry

The Smart key needs only to be on the driver's person while using a door handle. It does not need to be exposed.

The Smart key may not be detected if it is placed in a metal container, or if it is shielded by a device with a back-lit LCD screen, (e.g., laptop, smart phone, etc). Keep the Smart key clear of such devices when attempting Keyless entry or Keyless starting. Loose coins in the same pocket as the Smart key can also act as a shield.

Emergency key release

Slide the side section up, then pull sideways to remove. Remove the keyblade and unfold it. Use the blade to lever off the appropriate door lock cover. The cover has a key symbol embossed into it.

Insert the key into the exposed lock, then turn and release it to unlock.

If the security system was previously armed with the Smart key, when the door is unlocked, the alarm sounds. To disarm the alarm, position the Smart key as shown below. Press the unlock button, or press the **START/STOP** button with the Smart key inside the vehicle.

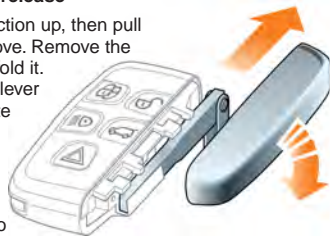

Operating note

If the Smart key fails to work, hold it under the steering column in the indicated position. Start the engine as normal. The Smart key can now be removed.



Powered tailgate *See page 2, item 26.*

1. To release the tailgate:

- Press the external release switch,
- Use the Smart key or,
- Press the internal release switch.

A powered tailgate continues to open to the set height.

2. To close the powered tailgate:

- Press and release the switch or,
- Press the Smart key tailgate button.

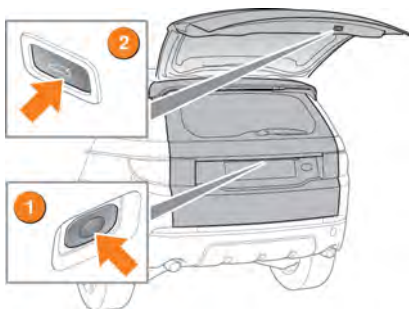

Comfort adjustments

Electric seat adjustment *See page 2, item 30.*

The driver's seat can be adjusted in up to 10 directions. The controls are located on the outer edge of the seat.

1. Lumbar support.
2. Seat back angle.
3. Seat height.
4. Seat forward and rearward.
5. Cushion angle tilt.

Memory settings

If seat memory is available, the driver's seat and exterior mirror positions can be saved for future use. Up to 3 sets of seat and mirror positions can be saved at any one time.

6. When the required positions have been achieved, press the **M** button on the driver's door.
7. Within 5 seconds, press buttons **1**, **2**, or **3** to store the current driving position to the chosen number. An existing setting on that button is over-written.

A stored memory position can be recalled with a press of the appropriate button; **1**, **2**, or **3**. The seat and mirrors move to their preset positions.

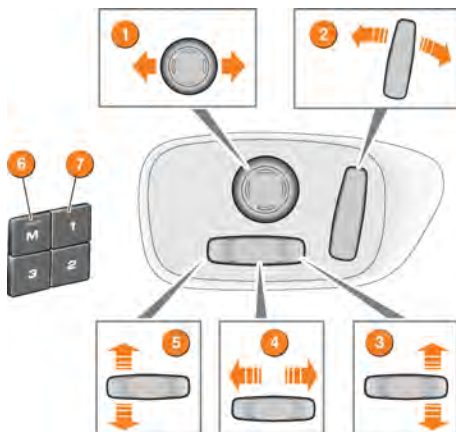

Operating note

Memory seat buttons **1**, **2**, or **3** must be pressed within 5 seconds after pressing the **M** button, otherwise, the memory store function cancels.

Passenger airbag deactivation - not Australia

If a child restraint is fitted to the front passenger seat, the passenger airbag **MUST** be deactivated.

To disable/enable the front passenger airbag, use the left side steering wheel controls to access the Instrument panel **Main Menu**.

1. Select **Vehicle Set-up**.
2. Select **Passenger Airbag** to display the current status.
3. Select **Passenger Airbag On or Off**, as required.

The status indicator in the overhead console illuminates while the ignition is on and **Passenger Airbag Off** is selected.



Comfort adjustments

Seat belt reminder



A warning indicator in the Instrument panel illuminates if the driver's seat belt is unbuckled. This may be accompanied by an intermittent chime.

While the ignition is on, the Message centre displays a graphic reminder of seating positions and seat belt use.

- A tick in a circle indicates that a seat belt is fastened.
- A cross in a circle indicates that a seat belt is unfastened. After 30 seconds with the seat belt unfastened, this changes to an empty grey circle.

- An empty grey circle indicates that the associated seat belt is not fastened.



An audible warning will sound if a seat belt is unfastened while the vehicle is moving.

Automatic climate control *See page 2, item 10.*

Touch **Climate** on the Home menu screen to display the **FRONT CLIMATE** screen.



- Press and hold to activate continuous recirculation. Screen misting can occur.
 - Press again to turn off.
12. Heated rear screen.
 13. Heated windscreen.
 14. **A/C**. For cooled and dehumidified air.
 15. Temperature controls. Rotate to adjust the temperature.
 16. Maximum defrost. Fastest method to remove frost or heavy misting from the windscreen. Press again to switch off.
 17. Press to display the **FRONT CLIMATE** screen.
 18. Blower control. Rotate to adjust airflow through the vents. LEDs indicate the current speed selection.
 19. **AUTO** mode. For fully automatic operation.
 20. **MAX A/C**. Maximum air conditioning program.

1. Front climate seats settings.
2. Third row seats climate settings.
3. Touch to select the Timed Climate settings menu.
4. Climate control system off.
5. Windscreen air distribution.
6. Air distribution.
7. Rear A/C is locked.
8. Touch to synchronise front Climate zones.
9. Climate settings menu.
10. Front heated seats on/off or Climate seats settings menu.
11. Recirculation.
 - Press briefly to activate for a set timed recirculation period.

Operating notes

AUTO is the recommended climate control operating mode. This helps to prevent misting.

Heated and Climate seats only operate while the engine is running. This is to prevent the vehicle battery becoming discharged.

External water deposits

The air conditioning system removes moisture from the air and deposits the excess water beneath the vehicle. Puddles may form, but this is normal and no cause for concern.

Starting and stopping the engine *See page 2, item 7.*

Engine start

1. The Smart key must be inside the vehicle.
2. The transmission must be in either the **P** or **N** position.
3. For automatic transmission, press the brake pedal. For manual transmission, press the clutch pedal.
4. Now press and release the **START/STOP** button. The engine will start.
5. Press the button again to stop the engine and switch off the ignition.

Diesel engine starting

In extreme low temperatures, there may be a delay of up to 12 seconds between the **START/STOP** button being pressed and the engine cranking.

Make sure that the brake pedal or clutch remains pressed. **DO NOT** press the **START/STOP** button again. Cranking time will be increased.

Smart key use

The engine continues to run, even if the Smart key is removed from the vehicle. However, if the engine is stopped, it cannot be restarted until the Smart key is returned to the vehicle.

Warning and information lamps

The following lamps may illuminate in the Instrument panel during normal driving, to indicate that a related system or feature is operating. If any other lamp illuminates, refer to the Owner's Handbook. DO NOT ignore warning lamps.



Seat belt reminder.



Rear fog lamps on.



Front fog lamps on.



EPB applied.



Diesel glow plugs active.



Side lamps on.



A message is available in the Message centre.



Cruise control active.



Trailer attached.



DSC switched off.



HDC active.



Auto high beam is on.



ACC Follow mode active.



Forward alert active.



Headlamp high beam on.

Instrument panel menu *See page 2, items 3 and 22.*

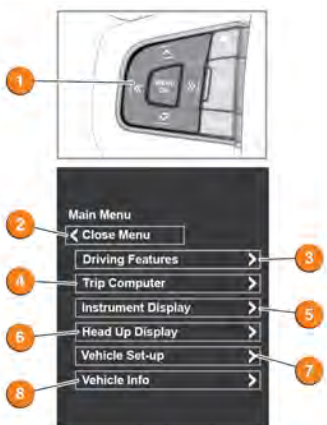

A number of vehicle features and display settings may be configured via the Instrument panel menu.

To display and navigate through the menu, press the **MENU OK** button on the steering wheel, then use the direction buttons to navigate through the menu. Press **MENU OK** to make selections.

1. Steering wheel menu control.
2. Close or return to the **Main Menu**.
3. Access the vehicle's **Driving Features** menu.
4. Access the **Trip Computer** menu.
5. Access the **Instrument Display** menu.
6. **Head-Up Display (HUD)** menu.
7. Access the **Vehicle Set-Up** menu.
8. Access the **Vehicle Info** menu. Available only before the engine is started.

Automatic transmission *See page 2, item 14.*

The rotary selector elevates from the console at engine start-up. Gear selections can be made with either the rotary selector or with the gearshift paddles.

1. With the engine running and transmission **P** selected, apply the brake pedal. Rotate the selector to **R** or **D**.
2. **Sport** mode. This is an automatic gear change mode, however, change points are modified to make full use of engine power. Press down the selector and rotate to **S**. The gear position indicator illuminates.
3. **CommandShift™** mode. This is an alternative to the automatic modes and is effective when rapid acceleration or engine braking is required. With **S** selected, use the left gearshift paddle (-) for downshifts and the right gearshift paddle (+) for upshifts.
4. To change gear, pull either gearshift paddle towards the steering wheel, and release.



The Message centre displays the selected gear.

Gear shift indicator



When manually selecting gears, the indicator illuminates briefly in the Instrument panel, at the recommended point for a gear change.

Intelligent stop/start *See page 2, item 17.*

To activate an automatic engine stop:

With automatic transmission, apply sufficient brake pressure to make sure the vehicle is stationary.

With manual transmission, stop the vehicle, select neutral and fully release the clutch.

A stop/start icon illuminates in the Instrument panel.

The engine restarts when the brake pedal is released, and a drive gear is selected, or for manual transmission, when the clutch is pressed.

To switch off, press the Intelligent stop/start switch. The stop/start icon extinguishes while Intelligent stop/start is deactivated.



Operating note

When the vehicle comes to a stop, make sure that your feet do not touch the clutch or accelerator pedals. Inadvertent pressure will prevent the engine from stopping.

Adaptive cruise control (ACC) *See page 2, item 19.*

ACC is designed to maintain a gap to the vehicle ahead, or a set road speed if there is no slower vehicle ahead. A speed may be set between 32 km/h and 180 km/h.

1. PresPress to switch between ACC and Automatic speed limiter.
2. Press to increase or set the speed.
3. Press to resume the previous set speed retained in the vehicle's memory. A set speed is cleared at ignition switch off.
4. Press to cancel but retain the set speed to the vehicle's memory.
5. Press to decrease the set speed.
6. Press to decrease the Follow mode gap.
7. Press to increase the Follow mode gap.

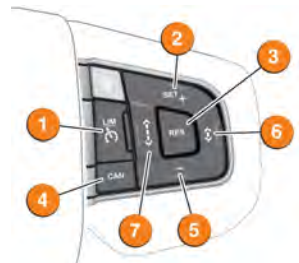

Electric parking brake (EPB) *See page 2, item 15.*

Applying

With the vehicle stationary, pull up the EPB switch and then release it. A red lamp in the Instrument panel illuminates continuously until the brake is released.

- With automatic transmission, the EPB automatically applies when transmission **P** is selected.
- With manual transmission, the EPB automatically applies if the ignition is switched off and the vehicle's speed is below 3 km/h.

Releasing

With the ignition on, apply the brake pedal, press down on the EPB switch and then release it. The red lamp in the Instrument panel extinguishes.

- With automatic transmission and either **D** or **R** selected, pressing the accelerator automatically releases the EPB.
- With manual transmission, automatic release can be effected in first, second, and reverse gears.

Exterior lamps *See page 2, item 1.*



Operating note

When driving abroad, there is no need to adjust the headlamp beam position.

1. **Outer collar.** Rotate to first position for side lamps, second position for headlamps, and the third position for **AUTO**. With **AUTO** selected, all exterior lamps switch on automatically when the ambient light fades.
2. **Inner collar.** Turn it away and release for front fog lamps. Turn it towards you and release for rear fog lamps. Turn and release again for off.

Headlamps high beam. Push the control forwards for high beam. To flash the headlamps, pull back and release.

Auto high beam. Active when set in the Instrument panel menu, **AUTO** is selected and low beams are in use. High beam will automatically activate when the sensor detects no light or very low light source ahead. Low beam is automatically selected when appropriate.

Wipers and washers *See page 2, item 6.*

1. With automatic rain sensing, the front wipers responds to rain severity. Without automatic rain sensing, move the control up to select intermittent delay.
2. With automatic rain sensing, rotate towards **MAX** to increase sensitivity. Without automatic rain sensing, rotate the collar towards **MAX** to increase the wiper frequency.
3. Low speed continuous wipe.
4. High speed continuous wipe.
5. Windscreen single wipe.
6. Windscreen wash/wipe.
7. Rear wiper. Rotate to **INT** for intermittent wipe. Wiper frequency increases with vehicle speed. Rotate to **ON** for continuous wipe.
8. Rear wash/wipe. Continue to hold for additional operation.

If freezing or very hot conditions are likely, the wipers can be set to the Winter park position so that they can be lifted from the windscreen and so avoid sticking. See **WINTER PARK POSITION** in the Owner's Handbook.



To prevent inadvertent wiper activation, turn the Automatic rain sensing off;

- Before entering an automatic car wash.
- During hot, dry and dusty periods.

Blind spot monitoring (BSM)

While a forward gear is selected and the speed is above 10 km/h, BSM will detect a vehicle approaching from behind, on either side, within its scanned range. Detection range is approximately 6 m to the rear, and 2.5 m to the sides.

1. An amber icon, depicting an approaching vehicle, illuminates in the relevant door mirror.
2. An amber dot illuminates when the vehicle's speed is below 6 km/h. BSM is active only when the amber dot extinguishes.



Park assist

Park assist can help the driver to manoeuvre into, and out of, a space. With Park assist activated and while driving forwards at a speed of less than 30 km/h, sensors identify a suitable space where the vehicle can be steered automatically into place. The driver operates only the accelerator and brake pedals. Park assist can also aid manoeuvring into a parking space and exiting from a parallel parked position.



Note: When Park assist is activated, a previous space may already have been located.

Note: For Park assist to search effectively, maintain a distance of 0.5 m to 1.5 m between the vehicle and the side on which you wish to park.

While searching for a parking space, use the following procedure:

1. Press briefly, to activate the system. A **Parallel Park** message is displayed in the Message centre. Press again for **Perpendicular Parking** and a third time for **Parking Exit**. Follow the displayed instructions. Press again to turn off.
2. When parallel or perpendicular parking, Park assist searches for a space on the side of the front passenger. To search for a space on the driver's side, signal a turn in that direction. The Park assist message appears in the Message centre.

3. As you drive forwards, potential spaces are assessed. A short confirmation tone sounds when a suitable space is found and a message is displayed.
4. Park assist instructs you to stop or to drive forward to a starting point, and when to select transmission **R**.
5. Park assist takes control of the vehicle's steering system. Release the steering wheel and apply the accelerator carefully, to move the vehicle slowly into the space. Use the brake pedal to stop, when instructed by Park assist.

Further manoeuvring may be required. Follow instructions in the Message centre.

6. When the manoeuvre is complete, **STOP!** is displayed.

Terrain response *See page 2, item 13.*

When the vehicle is started, Terrain response normally starts in its **General** program.

Program selection is via one of two types of centre console switches. Depending on vehicle specification, the control switches may include a **Dynamic** setting



Use the switches to select a program. This will adjust the vehicle's systems, including drive and suspension, to enhance driveability and traction on specific surface conditions and terrains. Icons illuminate, as selected. The Message centre also displays an icon.

Land Rover recommends that a special program be engaged whenever the driving conditions are difficult, and then moved back to the **General** program, once those conditions are no longer present.



Dynamic. Associated with driving style, rather than with a type of terrain. Dynamic selection allows the vehicle's full on-road potential to be explored. Handling and driving characteristics are enhanced while on hard surface roads.



General. Use for typical road surfaces.



Grass-Gravel-Snow. For surfaces which are firm but have a slippery surface, e.g., grass, snow, loose gravel, pebbles, or icy conditions.



Mud-Ruts. Suitable for soft, muddy, uneven, or rutted ground.



Sand. Suitable for soft, predominantly dry, yielding sandy ground, e.g., sand dunes and deserts. If the sand is damp or wet, the Mud-Ruts program may be more beneficial.

Wading

When wading through water, select the program most suitable for the surface beneath the water. **DO NOT** exceed 600 mm of water depth and enter the water with a shallow approach angle. **DO NOT** stop the vehicle or switch off the engine while wading. Severe electrical damage may occur. For further information, see **Wade sensing** in the Owner's handbook.

Parking aids

Front and rear Parking aids are activated when transmission **R** is selected. When a forward gear is subsequently selected, the Parking aids system remains active until the vehicle's forward speed exceeds 16 km/h.

If an obstruction is detected, an intermittent tone sounds. Moving closer to the obstruction increases the frequency of the tone.

Press the switch, to the left of the Touch screen, to deactivate. The switch illuminates. Press again to activate.



Rear camera

When transmission **R** is selected, the camera provides a rear-view image with overlaid guidance lines, to assist while reversing.

To view the Parking aids display instead, or to cancel the camera display at any time, press the **Home menu** button, or touch the Back soft key.

To adjust the camera settings while in reverse, touch anywhere on the Touch screen to display the user options.

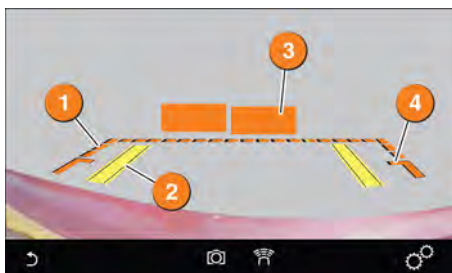

1. Broken line - full width of the vehicle.
2. Solid line - projected reversing path based on the current steering wheel position.
3. Parking sensor activation - shaded area indicates which of the 4 rear sensors are active.
4. Tailgate access guidance line - do not reverse beyond this point if tailgate access is required.

Touch screen Home menu and controls

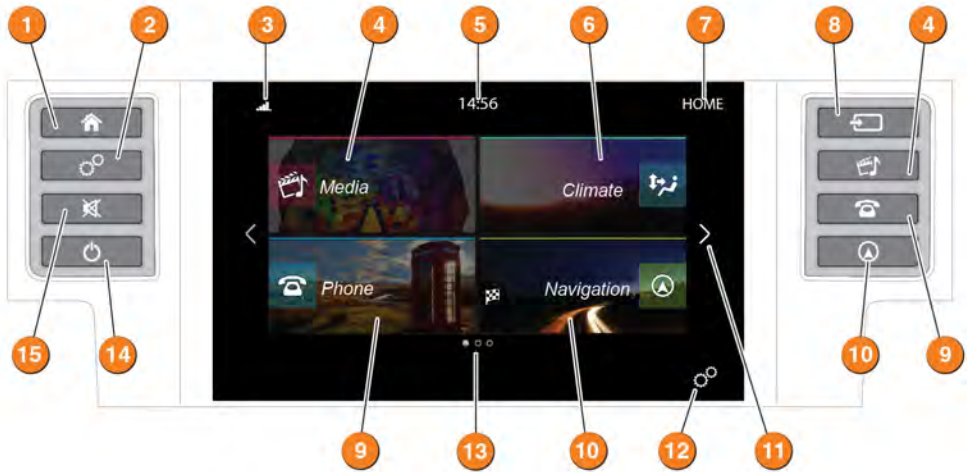

1. Direct access to the **HOME MENU**. Content depends upon vehicle specification and options selected.
2. Touch screen **General settings** menu. When Park assist is specified, this hard key turns Park assist on and off.
3. Status icons area. The displayed icons indicate the connected phone's network, phone battery level and network signal strength, and also TA and TP if they have been selected.
4. **Media** menu. An overview of current media information is displayed.
5. Clock. Time can be adjusted via the **General settings** menu.
6. **Climate** menu. An overview of current climate control information is displayed.
7. Screen title.
8. Touch to select the audio source.
9. **Phone** menu.
10. **Navigation** menu. The current set destination is displayed.
11. Extra Features. Touch the arrow or swipe the screen, to display the Extra features.
12. **General settings** menu.
13. Number of pages indicator. The solid dot indicates which of the available screens, is selected.
14. Screen on/off. Each time the ignition is turned on and this button is pressed, the **Home menu** is displayed. If the ignition remains on and the Touch screen is turned off and later turned on again, the last used screen or menu is displayed.
15. Touch to mute the sound. When Parking aids are fitted, this button is used for turning them on and off.

The Touch screen requires only light touches. Excess pressure could result in damage.

Radio

AM or FM radio can be selected from the source menu.

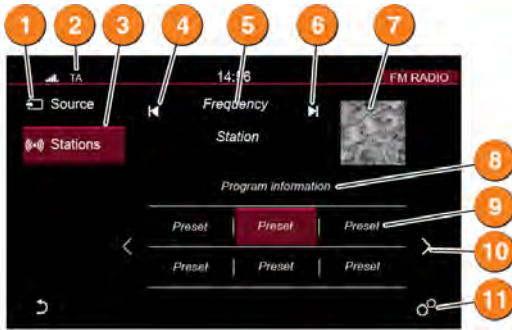

1. **Source.** Touch to view the media source list.
2. Status icons.
3. **Stations.** Displays the station list.
4. Auto-seek down to the next available channel.
5. Current radio station name and frequency.
6. Auto-seek up to the next available channel.
7. Waveband image (if available).
8. Current radio station information.
9. Station presets: Touch and release a preset to tune to the station stored on that preset. Touch and hold to store the current station to that preset. Use the steering wheel seek buttons to change to the next or previous preset stations.
10. Touch to scroll through the preset stations.
11. **General settings** menu.

DAB radio

Digital radio channels are arranged into groups called ensembles. Each digital channel may also have associated subchannels.

Note: Subchannels are temporary channels and may be discontinued at any time.

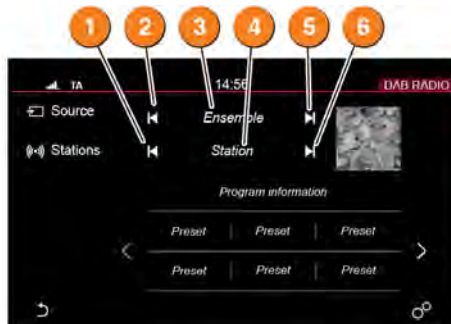

1. Auto-seek down to the next available radio station.
2. Auto-seek down to the next available radio ensemble.
3. Current radio ensemble name.
4. Current radio station name.
5. Auto-seek up to the next available radio ensemble.
6. Auto-seek up to the next available radio station.

*Note: If you attempt to select a preset channel that is now unavailable or invalid, **No reception** is displayed.*

Portable media

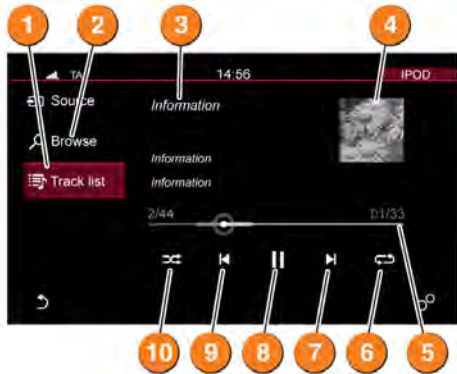

Includes iPod®, USB, AUX and **Bluetooth®** wireless technology devices.

1. **Track list.** Displays available tracks on the connected device.

Note: Sound quality and volume levels available from devices connected to the auxiliary input may vary widely.

2. **Browse.** Displays sub-menus of the connected device, e.g., **Playlists, Artists, Albums, Songs**, etc.
3. Information relating to the current audio output.
4. Image display. If an image is available for the current audio track, it will be displayed here. If a video source is about to be played, an image from the video will be displayed.
5. Progress bar. Drag the spot on the line, or touch the line at any point, to move forwards or backwards through the track.
6. Touch for continuous play.
7. Skip/scan forwards to the start of the next track, or, touch and hold to skip forwards through the current track being played. Playback resumes when the soft key is released.
8. Pause/Play: Select to pause playback. Select again to resume playback.
9. Skip/scan backwards to the beginning of the current track, or, touch and hold to skip back through the current track being played. Playback resumes when the soft key is released.

10. Shuffle. Touch to play random tracks from the currently connected device.

Connecting a portable media device

Portable media devices can be connected to the media hub located in the cubby box.



1. SD card slot for Navigation and Voice only.

Note: Note: Only use the SD card provided with the vehicle. The media system will not play music or display saved images from an SD card.

2. USB socket.
3. 3.5 mm AUX socket.

Note: Auxiliary devices have no Touch screen control.

Note: If an iPod is connected to the vehicle via its Bluetooth® wireless technology facility and also, via a USB cable, for music playback, make sure that the USB connection is made last.

If alternative connections are made, track title and time information will be shown on the Touch screen but no audio will be heard through the vehicle speakers. To address this issue, disconnect and reconnect the USB cable.

Steering wheel audio control *See page 2, item 22.*

Audio system selections can also be made from the left side steering wheel control.



1. Press repeatedly for mode options.
2. Volume decrease.
3. Seek/scan/skip down.
4. Volume increase.
5. Seek/scan/skip up.

Nav menu

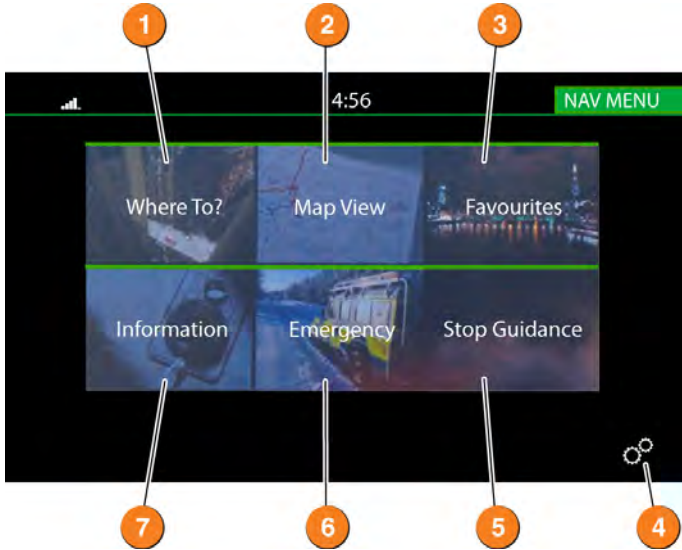

Country selection
On initial activation, make sure that both the correct country and search area have been selected.
For more information, refer to the Navigation section of the Owner's Handbook.

Selecting navigation

To access the Navigation system, press the Navigation hard button or touch **Navigation** on the **HOME** menu.

Note: At the first time of accessing the caution screen, set the required language.

1. **Where To?:** Touch for a list of options for setting a destination.
2. **Map View:** Touch for map view.
3. **Favorites:** Touch to view the list of any stored destinations.
4. **Settings:** Touch to view the General or Navigation settings menu.
5. **Stop Guidance:** Touch to cancel the current route guidance.
6. **Emergency:** Touch to see a list of Emergency services.
7. **Information:** Touch to display Traffic, Where am I, and Trip computer.

Setting a destination

To set route guidance, first select **Where To?**.

Choose one of the displayed guidance options and enter the required details.

When all of the details have been entered and the selection process is complete, there are 4 options:

1. **Yes:** Select to accept the selected destination and start guidance.
2. **Options:** When calculating a route, various options can be selected. Before accepting the requested route, touch **Options** to view the following list:
 - Fast.
 - Short.
 - Economical.
 - Route Alternative.
 - Round Trip.

Select the required option from the list.

3. **Avoid:** When calculating a route, a road to avoid can be set. Before accepting the requested route, touch **Avoid** to view the list of options. Select the required option from the list.
4. **Save:** When calculating a route, the destination can be saved as a favorite. Before accepting the requested route, touch **Save** to save the route to your Favorites.

Bluetooth® wireless technology devices

Bluetooth connectivity

Compatible **Bluetooth** wireless technology devices can communicate with the vehicle's in-built phone system. For the latest list of compatible phones and their software, refer to www.landrover.com. Select **OWNERS** and then **Bluetooth**.

Note: The process of pairing and connecting a phone to the vehicle varies, depending on the type of phone used. Use the manufacturer's instructions.

Connection must be made with the ignition on or the engine running.

Pairing and connecting using a phone

1. Switch the ignition on and make sure the Touch screen is active.
2. Select **General settings**, then **Bluetooth**.
3. From the list, select **Make system discoverable**.
4. Switch on your phone or device's connection. Make sure that your phone or device is in discoverable mode, sometimes referred to as find me mode (see your phone or device's operating instructions for more information).
5. A Passkey number appears on the phone or device. If this number matches the number on the Touch screen, touch **Yes**, or press **Pair** on the phone or device.
6. Once a phone or device is paired, it appears on the connected device's list and on the **PHONE** screen.

Pairing and connecting using the Touch screen

1. Switch on your phone or device's connection. Make sure that your phone or device is in discoverable mode, sometimes referred to as find me mode (see your phone or device's operating instructions for more information).
2. Switch the ignition on and make sure the Touch screen is active.
3. Select **General settings**, then **Bluetooth**.
4. The system searches for a phone or device and, if found, the phone or device displays on the screen. If the phone or device is not found, **No devices have been found** is displayed.
5. A Passkey number appears on the phone or device. If this number matches the number on the Touch screen, touch **Yes**.

Calls via the Touch screen



With a paired and active phone, touch **PHONE** on the Touch screen or press the button on the Touch screen surround.

1. Select **Messages**, **Contacts** or **Call lists**.
2. Touch to search for a new, or change to another, paired phone or device.
3. Touch to display the keypad. Use the keypad to enter a phone number.
4. To make a call, touch the green connect icon. The icon changes to a red connected call icon. To end a call, touch the red icon.

Calls via the steering wheel controls

See page 2, item 22.

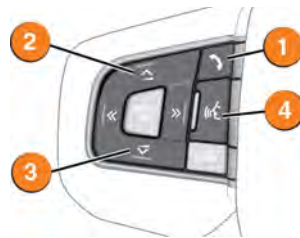

1. Press to answer a call or to make a call. Press again to end a call.
2. Press to increase the call volume.
3. Press to decrease the call volume.
4. Voice control talk button. The screen will display available options. Wait for the voice symbol to appear and a tone to sound before saying a command.

Refuelling



The fuel filler flap is located on the right side of the vehicle. If the vehicle is locked, the filler flap cannot be opened.

Press the flap at the rear edge to unlatch it. Open the flap fully.

Twist the cap counter-clockwise to release.

After refuelling, tighten the cap until it clicks 3 times.

The correct fuel specification for your vehicle is shown on the inside of the fuel filler flap.

- **DO NOT** use E85 fuels (85% ethanol content). Equipment necessary for the use of fuels containing more than 10% ethanol is not fitted to this vehicle. If E85 fuels are used, serious engine and fuel system damage will occur.
- **DO NOT** use RME (bio-diesel), except in the case of those proprietary diesel fuels which contain a mix of up to 7%. Land Rover can accept no responsibility for damage caused by using RME in concentrations greater than 7%.
- For diesel vehicles, use diesel fuel to specification EN 590 with a maximum bio-diesel mix of 7%.

Filling with the wrong fuel

If the vehicle is filled with the wrong type of fuel:

- **DO NOT** start the engine!
- Call for qualified assistance!

Diesel misfuelling prevention

To help protect against a diesel fuel tank being accidentally filled with petrol, a prevention device is fitted in the filler neck. It activates if the wrong type of fuel nozzle is fully inserted. The narrow fuel nozzles associated with unleaded petrol pumps, causes a flap to close and so interrupts fuel flow.

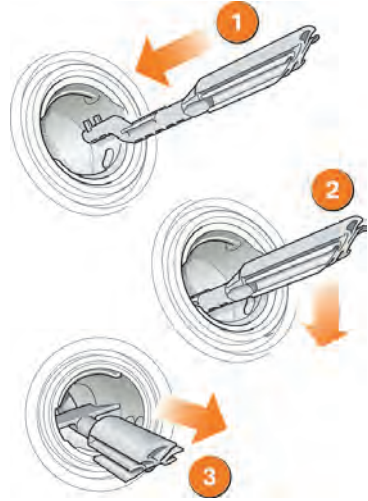

To reset the misfuelling device:

1. Insert the reset tool with the teeth uppermost, as far as it will go into the filler neck.
2. Locate the teeth, by pushing down the top of the reset tool.
3. With the top of the tool pressed down and the teeth engaged, slowly pull the tool out of the filler neck to reset the device.

Tyre pressure label

Tyre pressures are shown on a label attached to the pillar behind the driver's side door.