

# RANGE ROVER EVOQUE

## QUICK START GUIDE

- 2 DRIVER CONTROLS
- 3 VEHICLE ACCESS
- 4 COMFORT ADJUSTMENTS
- 6 DRIVING
- 11 TOUCH SCREEN
- 12 AUDIO/VIDEO
- 14 NAVIGATION SYSTEM
- 15 TELEPHONE
- 16 FILLING STATION INFORMATION



SOME FEATURES MAY NOT BE FITTED TO YOUR VEHICLE.

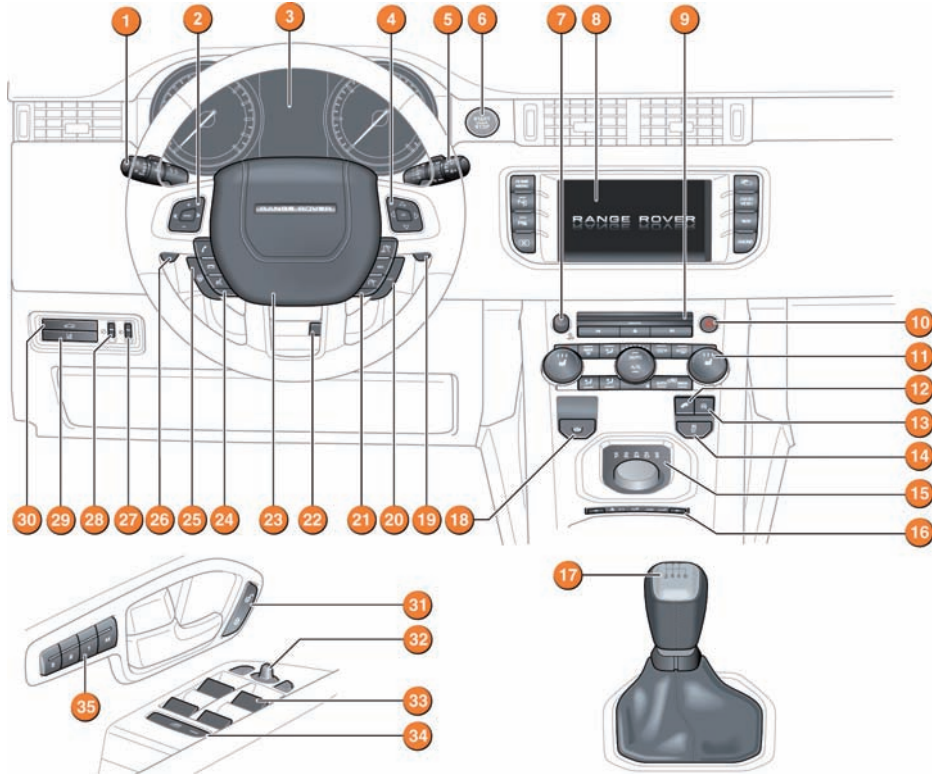



- |                                                                                                                                                                                                                                                                                                                                                                                                                                                                                                                                                                                                                                                                                                                                    |                                                                                                                                                                                                                                                                                                                                                                                                                                                                                                                                                                                                                                                                                                                                                                              |
|------------------------------------------------------------------------------------------------------------------------------------------------------------------------------------------------------------------------------------------------------------------------------------------------------------------------------------------------------------------------------------------------------------------------------------------------------------------------------------------------------------------------------------------------------------------------------------------------------------------------------------------------------------------------------------------------------------------------------------|------------------------------------------------------------------------------------------------------------------------------------------------------------------------------------------------------------------------------------------------------------------------------------------------------------------------------------------------------------------------------------------------------------------------------------------------------------------------------------------------------------------------------------------------------------------------------------------------------------------------------------------------------------------------------------------------------------------------------------------------------------------------------|
| <ul style="list-style-type: none"> <li>1. Headlamps, direction indicators and trip computer.</li> <li>2. Audio system control.</li> <li>3. Instrument panel, warning lamps and Message centre.</li> <li>4. Settings menu control.</li> <li>5. Wipers and washers.</li> <li>6. Engine START/STOP.</li> <li>7. Audio on/off and volume.</li> <li>8. Touch screen.</li> <li>9. Audio system.</li> <li>10. Hazard warning lamps.</li> <li>11. Heater/air conditioning.</li> <li>12. Hill descent control.</li> <li>13. Intelligent stop/start.</li> <li>14. Stability control.</li> <li>15. Gear selector.</li> <li>16. Terrain response.</li> <li>17. Manual transmission gear lever.</li> <li>18. Electric parking brake.</li> </ul> | <ul style="list-style-type: none"> <li>19. Upshift gear paddle.</li> <li>20. Cruise control cancel or Adaptive cruise control switches.</li> <li>21. Cruise control or Adaptive cruise control switches.</li> <li>22. Steering wheel adjuster.</li> <li>23. Horn.</li> <li>24. Telephone and voice recognition controls.</li> <li>25. Heated steering wheel.</li> <li>26. Downshift gear paddle.</li> <li>27. Headlamp levelling control.</li> <li>28. Interior lamps dimming control.</li> <li>29. Lane departure warning button.</li> <li>30. Tailgate release.</li> <li>31. Central locking switches.</li> <li>32. Mirror adjuster/power fold mirror.</li> <li>33. Window controls.</li> <li>34. Rear windows isolation.</li> <li>35. Driving position memory.</li> </ul> |
|------------------------------------------------------------------------------------------------------------------------------------------------------------------------------------------------------------------------------------------------------------------------------------------------------------------------------------------------------------------------------------------------------------------------------------------------------------------------------------------------------------------------------------------------------------------------------------------------------------------------------------------------------------------------------------------------------------------------------------|------------------------------------------------------------------------------------------------------------------------------------------------------------------------------------------------------------------------------------------------------------------------------------------------------------------------------------------------------------------------------------------------------------------------------------------------------------------------------------------------------------------------------------------------------------------------------------------------------------------------------------------------------------------------------------------------------------------------------------------------------------------------------|

## Smart key

-  Press once to switch the approach lamps on. Press again to switch off.
-  Press to unlock and release the tailgate. A powered tailgate will open to the set height. If the alarm is armed, it will be inhibited while the tailgate is open.
-  Press and hold for 3 seconds to activate/cancel the panic alarm.

## Unlocking mode alternatives

-  **Single-point entry**  
Press once to unlock only the driver's door and the fuel filler flap. Press twice to unlock all doors, the fuel filler flap and the Luggage area.

- Multi-point entry**  
Press once to unlock all doors, the fuel filler flap and the Luggage area.

To change the mode - with the vehicle unlocked, press and hold the lock and unlock buttons simultaneously for 3 seconds. The hazard warning lamps will flash to confirm the change.

## Keyless entry

The Smart key needs only to be on the driver's person while using a door handle. It does not need to be exposed.

## Operating note

The Smart key could be shielded and undetected if placed in a metallic container, or behind a device with an LCD screen, such as a smart phone, laptop (including in a laptop bag), games console, etc. Loose coins in the same pocket as the Smart key can also act as a shield. Keep the Smart key clear of such devices when attempting Keyless entry or Keyless starting.

## Emergency key release

Slide the side section up to remove. Remove the key blade and unfold it. Fully insert the key blade into the slot beneath the door lock cover embossed with the lock and key icons. Gently prise off the cover.

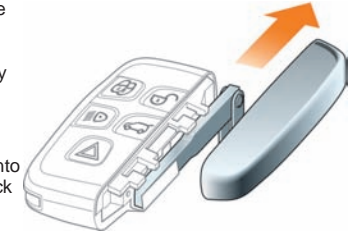

Insert the key into the exposed lock and unlock the vehicle.

If the security system was previously armed with the Smart key, when the door is unlocked, the alarm will sound. To disarm the alarm, press the unlock button on the Smart key, or press the **START/STOP** button with the Smart key inside the vehicle.

## Operating note

If the Smart key fails to work, hold it under the steering column in the indicated position. Start the engine as normal. The Smart key can now be removed.

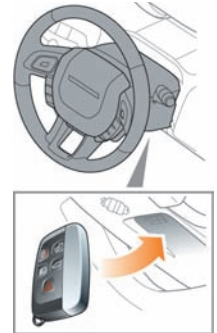

## Powered and manual tailgates See page 2, item 30.

1. To release the tailgate:
  - Press the external release switch,
  - Use the Smart key or,
  - Press the internal release switch.

A powered tailgate will continue to open to the set height.

2. To close the powered tailgate:
  - Press and release the tailgate button.

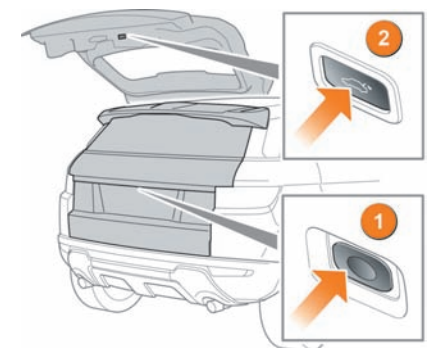

## Electric seat adjustment *See page 2, item 35.*

The driver's seat can be adjusted in up to 10 directions. The controls are located on the outer edge of the seat.

1. Lumbar support.
2. Backrest adjustment.
3. Cushion angle tilt.
4. Forward and back adjustment.
5. Height adjustment.

### Memory seats

Positions for driver's seat and exterior mirrors, can be stored in the vehicle's memory for future use. Up to 3 sets of seat and mirror positions can be saved at any one time.

1. When the required positions have been achieved, press the **M** button on the driver's door.
2. Within 5 seconds, press buttons **1**, **2** or **3** to store the current driving position to the chosen number. An existing setting on that button will be over-written.
3. A stored memory position can now be recalled with a press of the appropriate button; **1**, **2** or **3**. The seat and mirrors will move to their preset positions.

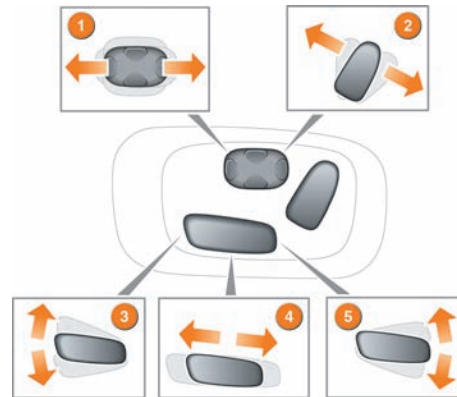

### Operating note

Memory seat buttons **1**, **2** or **3** must be pressed within 5 seconds after pressing the **M** button, otherwise the memory store function will cancel.

## Coupé rear seat access

The front seats can tilt and power slide forward, enabling access to the rear seats. Control is by a lever and a 2 way switch.

There are 2 types of seat. The Sport seat has the lever and switch panel located on opposite sides of the seat.

1. Lift the lever and pivot the seat forwards.
2. Press to power slide the seat forwards.
3. To return the seat to its previous position, pivot the seatback until it locks into position. Press the switch to power slide the seat backwards until it locks into position.

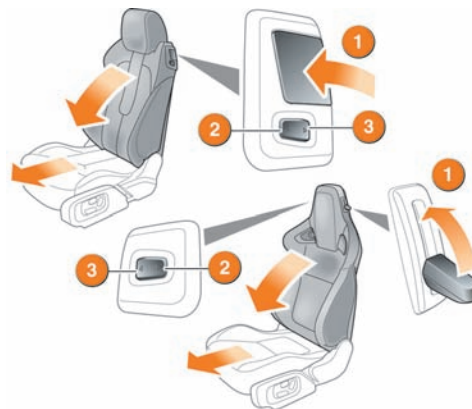

## Passenger airbag deactivation - not Australia

If a rearward-facing child restraint is fitted to the front passenger seat, the passenger airbag **MUST** be deactivated.

To disable/enable the front passenger airbag, use the right side steering wheel controls to access the Instrument panel **Main menu**.

Select **Vehicle Set-up**.

Select **Passenger Airbag** to display the current status.

Select **Passenger Airbag On** or **Off** as required.

The status indicator in the overhead console, will be illuminated while the ignition is on and **Passenger Airbag Off** is selected.

## Seat belt reminder



A warning indicator in the Instrument panel will illuminate if a front seat belt is not fastened, or is unfastened while the vehicle is moving. This may be accompanied by an intermittent chime.

While the ignition is on, the Message centre also displays a graphic indicating the status of all seat belts.

- A tick in a circle indicates that a seat belt is fastened.
- A cross in a circle indicates that a seat belt has been unfastened. After 30 seconds with the seat belt unfastened, this will change to an empty grey circle.

- An empty grey circle indicates that the associated seat belt is not fastened.



An audible warning will sound if a seat belt is unfastened while the vehicle is moving.

## Climate control *See page 2, item 11.*

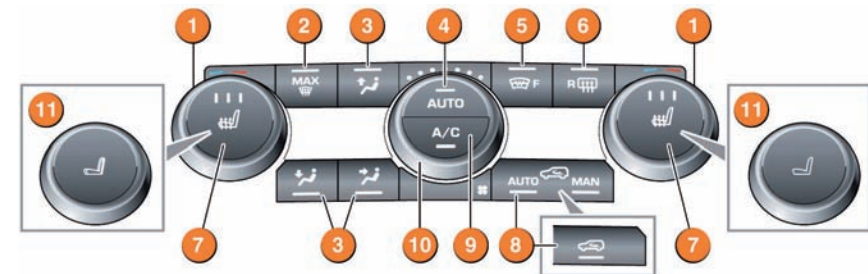

**AUTO** is the recommended operating mode. This will help to prevent misting.

1. Temperature controls. Rotate to adjust temperature.

*Note: The system allows temperature differential of up to 4°C (7°F) between the left and right passenger areas.*

2. Maximum defrost. Fastest method to remove frost or heavy misting from the windscreen. Press again to switch off. Screen heaters will remain on.
3. Air distribution. More than one setting can be selected simultaneously.

- Windscreen and side window vents.
- Foot level.
- Face level.

4. **AUTO** mode. The system will adjust the air conditioning, blower speed, and airflow distribution to maintain the selected temperature(s) and reduce misting without constant manual adjustments.

5. Heated windscreen.
6. Heated rear screen.

7. Seat heaters. Press to turn on to high, twice to turn on to medium, three times to turn on to low and a fourth time to turn off.

8. Recirculation.

**With an air quality sensor:** Press once to automatically restrict the entry of fumes. Press twice for a timed recirculation. Extended use of this setting causes screen misting. Press again to cancel recirculation.

**Without an air quality sensor:** Press once to activate a timed recirculation. Press and hold to activate continuous recirculation. Screen misting can occur. Press again to cancel recirculation.

9. **A/C**. For cooled and dehumidified air. Press again to switch the air conditioning off.

10. Blower control. Rotate to adjust airflow from the face vents. LED's indicate the current speed selection.

11. Front climate seats. Press to view the Touch screen menu. Provides a choice of Heated ventilation, Cooled ventilation, and Seat zone selection. Touch the display arrows to adjust to the required selection.

### External water deposits

The air conditioning system removes moisture from the air and deposits the excess water beneath the vehicle. Puddles may form, but this is normal and no cause for concern.

## Ignition on and engine starting *See page 2, item 6.*

The **START/STOP** button is operational only when the Smart key is inside the vehicle.

### Ignition on only

1. Press once to switch on the ignition.
2. Press again to switch off.

### Engine start

1. The gear selector must be in **P** or **N** position.
2. For automatic transmission, press the foot brake. For manual transmission, press the clutch pedal.
3. Now press and release the **START/STOP** button.

To stop the engine, press the button again.

### Diesel engine starting

In extreme low temperatures, the glow plug warning lamp may illuminate with a delay of up to 12 seconds between the **START/STOP** button being pressed and the engine cranking.













Make sure that the foot brake or clutch remains pressed. **DO NOT** press the **START/STOP** button again. Cranking time will be increased.

### Operating note

The **START/STOP** button must be pressed to stop the engine. If not, it will continue to run, even if the Smart key is removed from the vehicle.

## Warning and information lamps

The following lamps may illuminate in the Instrument panel during normal driving to indicate that a related system or feature is operating. If any other warning lamp illuminates, refer to the Owner's Handbook. **DO NOT** ignore warning lamps.

	Seat belt reminder.		Rear fog lamps on.		Front fog lamps on.
	Electric parking brake on.		Diesel glow plugs active.		Side lamps on.
	A message is available in the Message centre.		Cruise control active.		Trailer attached.
	DSC switched off.		HDC active.		High beam assist is on.
	ACC Follow mode.		Forward alert active.		Headlamp high beam on.

## Instrument panel menu *See page 2, item 4.*

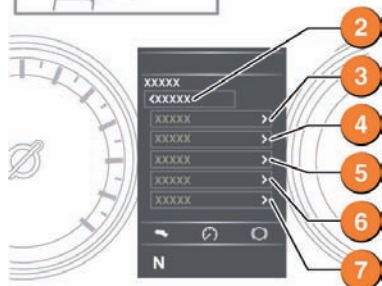

To disable/enable available features, use the right side steering wheel controls to access the Instrument panel **Main Menu**. Navigate through the **Vehicle Set-up** menu to the feature you want to change.

1. Steering wheel menu control.
2. Select to close and return to the **Main Menu**.
3. **Driving Features** menu.
4. **Trip Computer** menu.
5. **Instrument Display** menu for language, temperature units, and Instrument panel appearance.
6. **Vehicle Set-up** menu.
7. **Vehicle Info**. Can be accessed only while the engine is running.

## Transmission

Gear selections can be made with either the rotary selector or with the selector paddles. The rotary selector will elevate from the console at engine start up.

1. With the engine running and transmission **P** selected, apply the foot brake. Rotate the selector to **R** or **D**.
2. **Sport** mode. This is an automatic gear change mode, however, change points are modified to make full use of engine power. Press down the selector and rotate to **S**. The indicator alongside the selector will illuminate.
3. **CommandShift™** mode. This is an alternative to the automatic modes and is effective when rapid acceleration and engine braking are required. With **S** selected, use the left gearshift paddle (-) for downshifts and the right paddle (+) for upshifts.

4. With either paddle, pull it towards the steering wheel, and release, to make a gear change.

The Message centre will display the selected gear.

### Gear shift indicator



When manually selecting a gear, the indicator will illuminate briefly in the Instrument panel at the recommended point for a gear change.



## Intelligent stop/start *See page 2, item 13.*

To activate an automatic engine stop.

For automatic transmission, apply sufficient brake pressure to make sure the vehicle is stationary.

For manual transmission, stop the vehicle, select neutral and fully release the clutch.



A **ECO** icon will illuminate in the Instrument panel.

The engine will restart when the brake pedal is released, a drive gear is selected or for manual transmission the clutch is pressed.



To switch off, press the Intelligent stop/start switch. The **ECO** icon will extinguish while Intelligent stop/start is deactivated.

### Operating note

When the vehicle comes to a stop, make sure that your feet do not touch the clutch or accelerator pedals. Inadvertent pressure will prevent the engine from stopping.

## Adaptive cruise control *See page 2, item 21.*

The Adaptive cruise control (ACC) system is designed to maintain a gap to the vehicle ahead, or a set road speed if there is no slower vehicle ahead. A speed may be set between 32 km/h (20 mph) and 180 km/h (112 mph).

1. Press to activate ACC and to set a speed. Press briefly to increase the speed in 2 km/h (1 mph) steps.
2. Press to resume the previous set speed retained in memory. Set speeds are cleared at ignition off.
3. Pull to suspend ACC but retain the set speed in memory.
4. Press to decrease the set speed. Press briefly to decrease the speed in 2 km/h (1 mph) steps.
5. Pull to decrease the Follow mode gap.
6. Pull to increase the Follow mode gap.

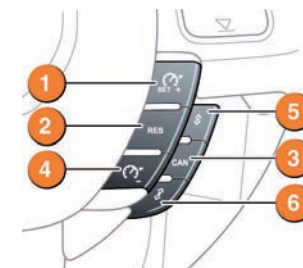

## Electric parking brake

See page 2, item 18.

### Applying

With the vehicle stationary, pull up the Parking brake lever and then release it. A red lamp in the Instrument panel will illuminate continuously until the brake is released.

- With automatic transmission, the Parking brake will automatically apply when transmission **P** is selected.
- With manual transmission, the Parking brake will automatically apply if the ignition is switched off and the vehicle's speed is below 3 km/h (2 mph).

### Releasing

With the ignition on, apply the foot brake and press down on the Parking brake lever.

With automatic transmission and either **D** or **R** selected, pressing the accelerator will automatically release the Parking brake.

With manual transmission, automatic release can be effected in first, second, and reverse gears.

To effect an automatic release, the driver's door must be closed or the driver's seat belt must be buckled.

## Exterior lights

See page 2, item 1.



**1. Outer collar.** First position for side lamps, second position for headlamps and the third position for **AUTO**. With **AUTO** selected, all exterior lamps will switch on automatically when ambient light fades.

**2. Inner collar.** Turn it away and release for front fog lamps. Turn it towards you and release for rear fog lamps. Turn and release again to turn off.

**Headlamps high beam.** Push the control forwards for high beam. To flash the headlamps, pull back and release.

**High beam assist.** Is active when set in the **Instrument panel menu/Vehicle Set-up**, **AUTO** position is selected and low beams are in use. High beam will then automatically activate when the sensor detects no light or very low light source ahead. Low beam will be automatically selected, when appropriate.

## Wipers and washers

See page 2, item 5.

**1.** With Automatic rain sensing, the front wipers will respond to rain severity.

Without Automatic rain sensing, move up to select intermittent delay.

**2.** With Automatic rain sensing, rotate towards **MAX** to increase sensitivity.

Without Automatic rain sensing, rotate towards **MAX** to increase the frequency of intermittent wipes.

**3.** Low speed continuous wipe.

**4.** High speed continuous wipe.

**5.** Windscreen single wipe.

**6.** Windscreen wash/wipe.

**7.** Rotate to **INT** for rear screen intermittent wipe. Frequency increases with vehicle speed. Rotate to **ON** for continuous wipe.

**8.** Rear wash/wipe. Continue to hold for additional operation.

If freezing conditions are likely, the wipers can be set to a higher position so that they can be lifted from the windscreen. See **Instrument panel menu**.

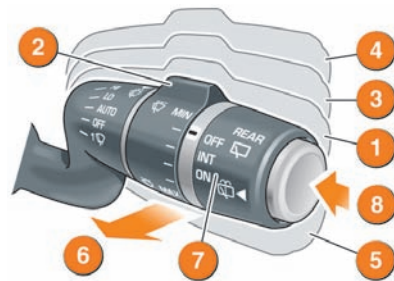

To prevent inadvertent wiper activation, turn the Automatic rain sensing off;

- Before entering an automatic car wash.
- During hot, dry and dusty periods.

## Blind spot monitoring

While a forward gear is selected and the speed is above 10 km/h (6 mph), the Blind spot monitor will detect a vehicle approaching from behind, on either side, within its scanned range. Detection range is approximately 6 m (20 ft) to the rear, and 2.5 m (8.2 ft) to the sides.

1. An amber icon, depicting an approaching vehicle, will illuminate in the relevant door mirror.
2. An amber dot will illuminate when the vehicle's speed is below 10 km/h (6 mph). The Blind spot monitor is active only when the amber dot is extinguished.

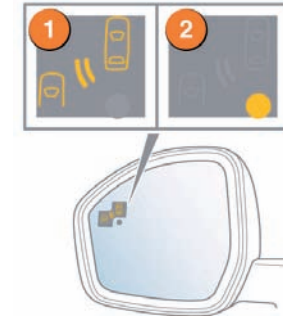

## Park assist

Park assist can help when parallel parking. When the system sensors identify a suitable space, the vehicle will be steered automatically into place while the driver operates the accelerator, brake, and clutch. The driver does not steer the vehicle. Park assist can also aid when using a parking bay and when exiting from a parked position.

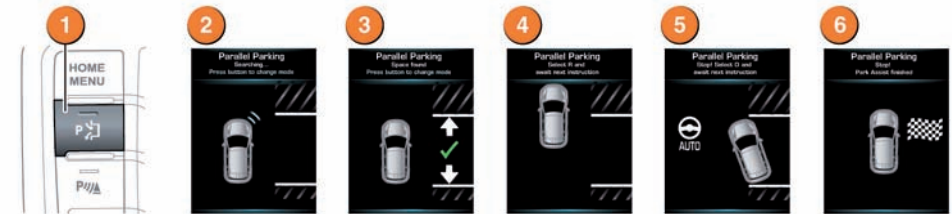

*Note: Park assist can find a parking space on either side of the vehicle. To search for a space on the driver's side, signal a turn in that direction.*

While searching for a parallel parking space:

1. Press once to activate while driving forwards at less than 18 km/h (11 mph).
2. Park assist searches for a space on the side of the front passenger unless the direction indicator has been used to select the driver's side. The Park assist message appears in the Message centre.
3. As you drive forward, potential spaces are assessed. A short confirmation tone sounds when a suitable space is found and a message is displayed.
4. Park assist will instruct to stop or to drive forward to a starting point, and when to select transmission **R**.

**5.** Park assist will then take control of the vehicle's steering system. Release the steering wheel and apply the accelerator carefully, to move the vehicle slowly into the space. Use the footbrake to stop, when instructed by Park assist.

Further manoeuvring may be required. Follow instructions in the Message centre.

**6.** When the manoeuvre is complete, **STOP!** will be displayed.

For instructions on Perpendicular parking and Park out, see the Owner's Handbook.

**Terrain response** See page 2, item 16.



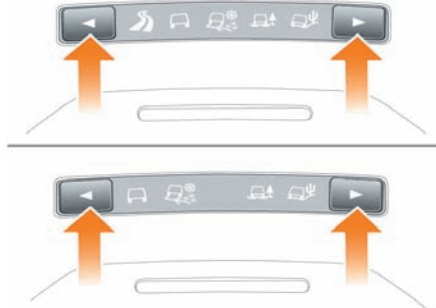

When the vehicle is started, Terrain response will normally start in its **General** program.

Program selection is via one of two types of centre console switches. Depending on vehicle specification, the control switches may include a **Dynamic** setting.



Use the switches to select a program. Icons will illuminate, as selected. The Message centre will also display an icon.

It is recommended that a special program be engaged whenever driving conditions are difficult, and then moved back to the **General** program, once those conditions are no longer present.

-  **General.** Use for typical road surfaces.
-  **Dynamic.** Associated with driving style, rather than with a type of terrain. Dynamic selection allows the vehicle's full on-road potential to be explored. Handling and driving characteristics are optimised for normal road surfaces.
-  **Grass-Gravel-Snow.** Suitable for surfaces which are firm but have a slippery surface, e.g., grass, snow, loose gravel, pebbles, or icy conditions.
-  **Mud-Ruts.** Suitable for soft, muddy, uneven, or rutted ground.
-  **Sand.** Suitable for soft, predominantly dry, yielding sandy ground, e.g., sand dunes and deserts. If the sand is damp or wet, the Mud-Ruts program may be more beneficial.

**Parking aids**

Front and rear Parking aids are activated when transmission **R** is selected. When a forward gear is subsequently selected, the Parking aids system will remain active until the vehicle's forward speed exceeds 16 km/h (10 mph).

If an obstruction is detected, an intermittent tone will sound. Moving closer to the obstruction will increase the frequency of the tone.

Press the switch to deactivate.

The switch will illuminate. Press again to activate.



**Rear camera**

When transmission **R** is selected, the camera provides a rear-view image with overlaid guidelines, to assist while reversing.

To view the Parking aids display instead, or to cancel the camera display at any time, press the **Home menu** button, or touch the back soft key.

To adjust the camera settings while in reverse, touch anywhere on the Touch screen to display the user options.

- 1. Broken line - full width of the vehicle.
- 2. Solid line - projected reversing path based on the current steering wheel position.
- 3. Parking sensor activation - shaded area indicates which rear sensors are active.

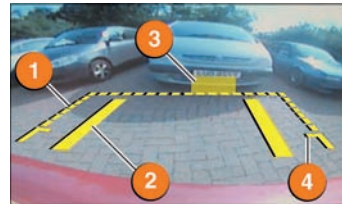

- 4. Tailgate access guideline - do not reverse beyond this point if tailgate access is required.
- 5. Touch to enable/disable graphics and guidance lines,
- 6. Hitch assist. Designed to aid the process of guiding the vehicle to the trailer tow hitch, a single line is displayed as the reversing guideline.
- 7. Auto-towball zoom. As the vehicle closes to within 600 mm (24 in) of the tow hitch, an automated zoom is operated.

**Touch screen**

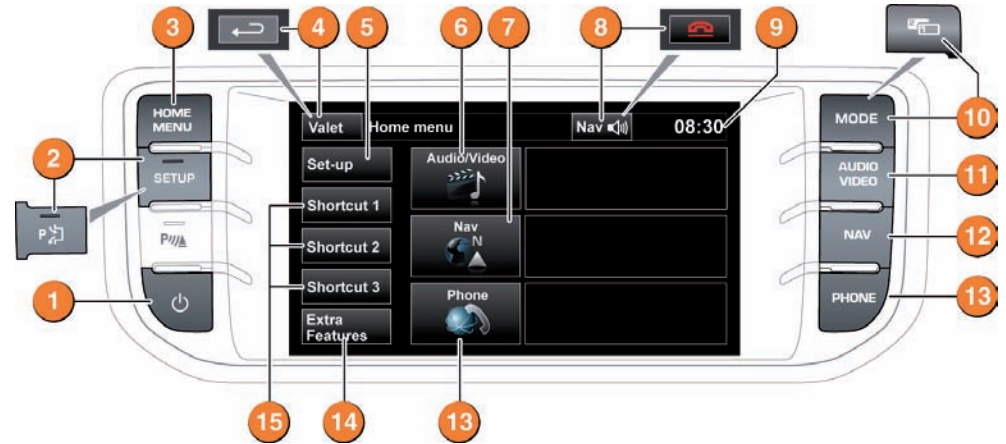

- 1. Screen on/off. Each time the ignition is turned on and this button is pressed, the **Home menu** will be displayed. If the ignition remains on and the Touch screen is turned off and later turned on again, the last used screen or menu will be displayed.
- 2. **SETUP.** Provides direct access to the **Set-up** menu. When Park assist is specified, this button position will turn Park assist on and off. The **Set-up** menu is then accessed via the Touch screen.
- 3. Direct access to the **HOME MENU**. Content will depend upon vehicle specification and options selected.
- 4. **Valet mode.** Locks the luggage areas and prevents access to the Touch screen when allowing others, e.g., a parking attendant, to take charge of your vehicle. You will have to enter a 4 digit code of your choice. When you re-enter the vehicle, use the code to unlock this security feature. During menu mode, the icon changes to the Back soft key. Touch to return to the previous screen.
- 5. **Set-up** menu.
- 6. **Audio/Video** menu. An overview of current audio/video information is displayed.
- 7. On road **Navigation** menu. The current set destination is displayed.
- 8. Touch to repeat the last navigation voice instruction. During a phone call, the icon is temporarily changed to indicate a call is in progress. Touch to end the call.
- 9. Touch to select time or date adjustment.
- 10. **MODE.** Press repeatedly to scroll through all audio/video sources. When Dual view is fitted, the button icon is changed. The button should then be pressed to access the Dual view screen display.
- 11. **AUDIO VIDEO** menu.
- 12. **NAV.** Touch to select Nav menu 1 of 2 screens.
- 13. **PHONE** menu.
- 14. **Extra Features.** There are more features available than can be displayed at one time. Touch to display the feature list and then use the forward and back soft keys to progress through it.
- 15. **Shortcut keys.** Use for personal shortcuts to any part of the system. Shortcuts can be made in the **Set-up** menu. Items in the **Extra Features** list can be set as a shortcut. The shortcut softkeys can be changed at any time.

Radio

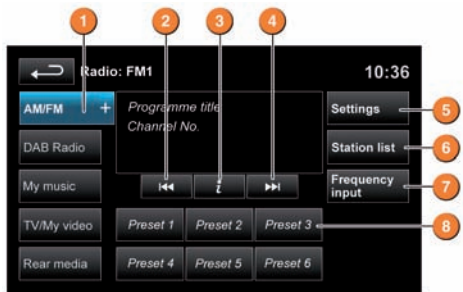

1. Touch to view and select a waveband.
2. Seek down: Short touch to auto seek down to the next radio station. Long touch to activate manual seek mode.
3. Information from the current station.

4. Seek up: Short touch to auto seek up to the next radio station. Long touch to activate manual seek mode.
5. Touch to view and activate/deactivate: **RDS, Traffic, News, AF and REG.**
6. Touch to view a list of available stations on the FM waveband.
7. Touch to enter a station frequency on the current waveband, using the numeric keypad. Select OK or wait for automatic tuning.
8. Station presets: Touch and release a preset to tune to the station stored on that preset. Touch and hold to store the current station to that preset.

DAB radio

Digital radio channels are arranged into groups called ensembles. Each digital channel may also have associated subchannels.

*Note: Subchannels are temporary channels and may be discontinued at any time.*

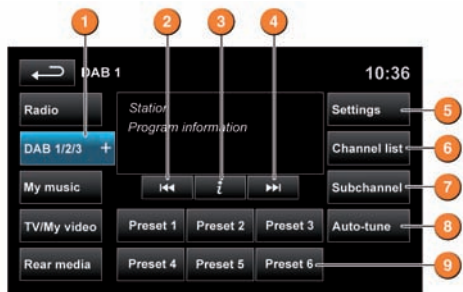

1. Touch to view and select a DAB band (DAB 1, 2 or 3). The radio will tune to the last used channel on that band. Touch again to close.
2. Seek down: Short touch to seek the previous available channel. Long touch to seek the previous available ensemble. The first channel in the new ensemble will be selected.
3. Touch to view DAB text and channel information.
4. Seek up: Short touch to seek the next available channel. Long touch to seek the next available ensemble. The first channel in the new ensemble will be selected.

5. Touch to view:
  - Options:** activate/deactivate **FM Traffic** and **Link DAB** and to alter **DAB country** and **DAB format** settings (with the vehicle stationary).
  - Announcements:** select an alarm announcement and up to 3 other announcement types from the list. Selected types will interrupt the current programme, when broadcast.
6. Touch to view a list of available ensembles and channels. The list can be sorted by **Ensemble, Channel, Subchannel**, or by **Category**. If an ensemble is selected from the list, all available channels from that ensemble will be displayed. Sorting by **Subchannel** is only available when the current channel is broadcasting subchannels. If **Category** is selected, touch the chosen category to view corresponding channels, before making your selection from the list.
7. If subchannels are broadcast by the current channel, **Subchannel** will be active. Touch and then select the required subchannel with the seek soft keys.
8. Select to scan for all available DAB ensembles/channels. This needs to be done before using the DAB radio for the first time. **Auto-tune** is also useful when travelling long distances, so regional ensembles can be tuned.
9. Station presets: Touch and release a preset to tune to the station stored on that preset. Touch and hold to store the current station to that preset.

*Note: If you attempt to select a preset channel that is now unavailable or invalid, **No reception** is displayed.*

Portable media



Includes CD, iPod®, USB, AUX and **Bluetooth®** wireless technology devices. The full infotainment system also includes Stored CD.

1. Touch **My music** then **Source** to display all options. Select an option.

*Note: Sound quality and volume levels available from devices connected to the auxiliary input may vary widely.*

2. Touch to switch traffic and news on or off. Additionally, for MP3 recorded media, you can select the number of list entries that are skipped when you use the page up/down arrows.
3. Touch to view the current CD or Stored CD track list. Select a track to start playback.
4. Touch to view contents of the connected device and start playback.
5. Touch to view and manage the Stored CD memory.

- Select **Upload** alongside an empty slot to upload a CD. There are 10 slots available.
- Select **Replace** to overwrite an existing CD.

*Note: Loading time is dependent on content type. Other features can be selected while upload is in progress.*

6. Skip/Scan forwards.
7. **Repeat**  
In CD mode:
  - Touch to repeat the current track continuously. Touch again to repeat the current Stored CD (or folder for MP3 discs) continuously until **Repeat** mode is cancelled. Touch again to cancel.

In USB or iPod mode:

- Touch to repeat the current track continuously. Touch again to repeat the current USB folder or to cancel iPod **Repeat** mode. Touch again to cancel USB **Repeat** mode.

*Note: Repeat mode is not available for Bluetooth wireless technology devices.*

8. Pause/Play: Select to pause playback. Select again to resume playback.

9. Information about the current track.

10. Touch to play random tracks from the current source. Touch again to cancel.

*Note: Shuffle mode is not available for Bluetooth wireless technology devices.*

11. Skip/Scan backwards.

Connecting a device

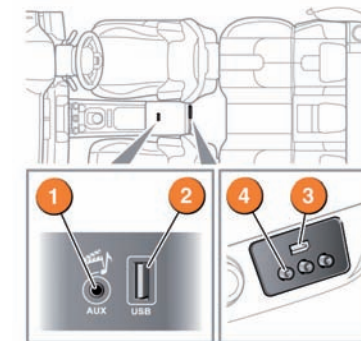

1. USB/iPod sockets.
2. 3.5 mm AUX socket.
3. Rear media USB/iPod socket.
4. Rear media AV sockets.

Steering wheel audio control *See page 2, item 2.*

Audio system selections can also be made from the left side steering wheel control.



1. Volume increase.
2. Press repeatedly for options.
3. Seek up.
4. Volume decrease.
5. Seek down.

## Nav menu

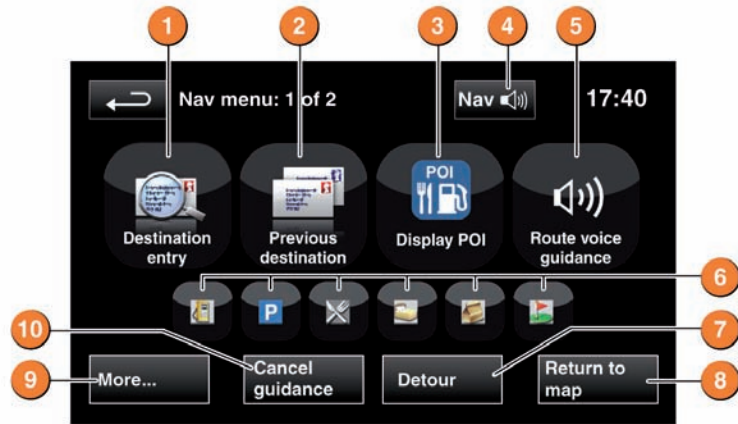

1. Use to enter a new destination. Provides a choice of options when entering a destination.
2. Displays previous destinations entered. Previous destinations can be selected.
3. Turns the POI (Point of interest) icons on the map on/off.
4. Only visible when a destination is set. Enables the last voice instruction to be repeated.
5. Highlighted while **Route voice guidance** is enabled. Touch to turn **Route voice guidance** off.
6. POI shortcuts: Touch the relevant icon to list available POIs that are close to the vehicle's position.
7. Calculates a detour from the current route.
8. Advances to the main map screen.
9. Move to the other Navigation menu. There are 2 navigation menu screens. On the second screen:
  - Stored locations** is used to manage the stored data. **TMC** (Traffic message channel) will provide data about road conditions and any events ahead that may affect the current route.
  - Route options** allows the selection of various options for the route.
  - Nav set-up** is for setting personal preferences within the Navigation system. Use the **More...** soft key to toggle between them.
10. Cancels the current route guidance.

### Selecting navigation

After touching **Continue**, the touch screen will display the previously displayed map screen.

*Note: At the first time of accessing the caution screen, set the required language.*

### Setting a destination

Select **Destination entry**.

Select **Address** and enter address details using the keyboard. As each part of the address is refined, touch **OK** or **List** to display all of the streets and towns that are available to be selected. If the house number is not known, press **OK**. The end of the road is then used as the destination.

When the map screen is displayed, you have the option to **Review route** or **Go**. Touch **GO** to calculate the quick route and start guidance.

### Review route

There will be a choice of **3 Routes** or **Change route**.

**3 Routes** will display 3 different route options on the map. Select **Route 1, 2** or **3** by touching the respective box displayed on the right side of the map and then select **GO**.

Alternatively, select **Change route** and then **Route preferences** to alter the route settings. When changes are complete, touch **GO**.

## Telephone

### Bluetooth® wireless technology device compatibility

For the latest list of compatible phones and their software, refer to [www.landrover.com](http://www.landrover.com). Select **OWNERS** and then **Bluetooth**.

*Note: Device to vehicle is the recommended method. The process of pairing and connecting a phone to the vehicle will vary depending on the type of phone used. Use the manufacturer's instructions.*

### Pairing and connecting using the phone

1. Switch the ignition on and make sure that the Touch screen is active.
2. From the **Home menu**, select **Phone**.
3. A menu will appear. If no phone is connected, select **Search new**, otherwise, select **Change phone** and then select **Search new**.
4. Select the **Device to vehicle** option.

*Note: The vehicle's Bluetooth wireless technology system is discoverable for only 3 minutes.*

5. Using the phone, search for Bluetooth wireless technology devices. On some phones, this is referred to as new paired device. See the manufacturer's instructions.

6. When the vehicle's system is discovered, begin the pairing process and follow the on-screen instructions.

7. When requested, enter a PIN of your choice into the phone and the vehicle's system.

8. Once your phone is paired, it may automatically connect to the vehicle's system. If not, use the device list shown on the Touch screen, or use the phone.

*Note: Some phones require the pairing to be set as 'authorised' or 'trusted' in order to automatically connect. Please refer to your phone's operating instructions for further information.*

### Downloading phonebook entries

When a phone with phonebook download capability is paired and docked, its phonebook directory can be automatically downloaded to the vehicle's system.

See **PHONEBOOK** in the Owner's Handbook for more information.

### Calls via the Touch screen



With a paired and active phone, press the **PHONE** button on the Touch screen surround.

1. Select **Digit Dial**, **Phonebook** or **Last 10**. With **Digit Dial** selected, use the keypad to enter the number. With **Phonebook** selected, choose a number from the downloaded phonebook. **Last 10** displays the previous 10 calls. Choose one to dial.

2. Touch the green connect icon to make a call. The icon will change to a connected call icon. Touch the red icon to end a call.

### Calls via the steering wheel controls

See page 2, item 24.



Connect. Press and release to send or accept a call, or to access the **Last 10** dialled list. Press and hold to access the **Phonebook**.



Disconnect. Use to end or reject a call.



Voice control talk button. The screen will display available options. Say **Phone** and follow the instructions.

The left side steering wheel audio controls can be used to adjust the telephone volume and to scroll through phonebook entries.

## Refuelling

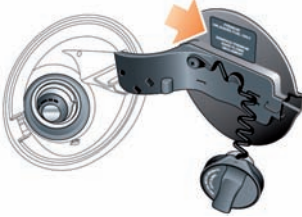

The fuel filler flap is located on the right side of the vehicle. If the vehicle is locked, the filler flap cannot be opened.

Pull the flap at the rear edge to open.

Twist the cap counter-clockwise to release.

After refuelling, tighten the cap until it clicks 3 times.

The correct fuel specification for your vehicle is shown on the inside of the fuel filler flap.

- **DO NOT** use E85 fuels (85% ethanol content). Equipment necessary for the use of fuels containing more than 10% ethanol is not fitted to this vehicle. If E85 fuels are used, serious engine and fuel system damage will occur.
- **DO NOT** use RME (bio-diesel), except in the case of those proprietary diesel fuels which contain a mix of up to 7%. Land Rover can accept no responsibility for damage caused by using RME in concentrations greater than 7%.
- For diesel vehicles, use diesel fuel to specification EN 590 with a maximum bio-diesel mix of 7%.

### Filling with the wrong fuel

If the vehicle is filled with the wrong type of fuel:

- **DO NOT** start the engine!
- Call for qualified assistance!

## Diesel misfuelling prevention

To help protect against a diesel fuel tank being accidentally filled with petrol, a prevention device is fitted in the filler neck. It will activate if the wrong type of fuel nozzle is fully inserted. The narrow fuel nozzle associated with unleaded petrol pumps will cause a flap to close and so interrupt fuel flow.

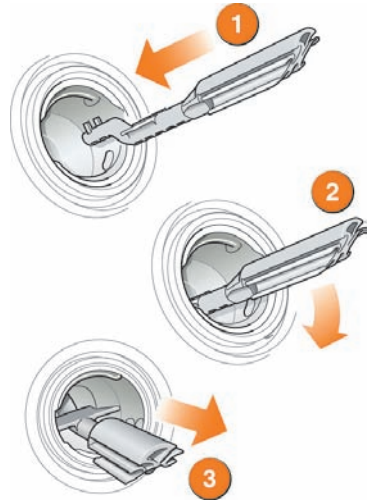

To reset the misfuelling device:

1. Insert the reset tool with the teeth uppermost, as far as it will go into the filler neck.
2. Locate the teeth by pushing down the top of the reset tool.
3. With the top of the tool pressed down and the teeth engaged, slowly pull the tool out of the filler neck to reset the device.

## Tyre pressure label

Tyre pressures are shown on a label attached to the pillar behind the driver's side door.