



## ACCESSORIES

### WARNING

Accessories which are not properly fitted can be dangerous. Read the instructions carefully prior to fitting. Whilst fitting, comply with the instructions at all times. If in doubt, contact your nearest Land Rover Dealer.

### ACHTUNG!

Nicht sachgemäß montiertes Zubehör kann gefährlich sein. Lesen Sie die Montageanleitung sorgfältig, bevor Sie das Teil montieren. Halten Sie sich bei der Montage an die Anleitung. Bei Unsicherheiten wenden Sie sich bitte an Ihren Land Rover Händler.

### AVERTISSEMENT

Les accessoires qui ne sont pas correctement montés risquent d'être dangereux. Veuillez lire soigneusement les instructions avant d'effectuer la pose. Respectez toujours les instructions en cours de pose. En cas de doute, consultez votre concessionnaire Land Rover local.

### AVVERTENZA

Gli accessori non sistemati come previsto possono essere pericolosi. Leggere attentamente le istruzioni prima del fissaggio. Durante il montaggio seguire sempre le relative istruzioni. In caso di dubbio rivolgersi al più vicino concessionario della Land Rover.

### AVISO

Aquellos accesorios que no hayan sido ajustados debidamente pueden resultar peligrosos. Lea las instrucciones detenidamente antes de iniciar el montaje. Durante el montaje siga las instrucciones en todo momento. En caso de duda póngase en contacto con su Concesionario de Land Rover.

### ADVERTÊNCIA!

Os Acessórios que não são montados adequadamente podem ser perigosos. Leia as instruções cuidadosamente antes de montar. Durante a montagem, obedeça as instruções todo o tempo. Se tiver alguma dúvida, contacte o Concessionário LandRover mais próximo.

### WAARSCUWING

Accessoires die niet op de juiste wijze zijn gemonteerd kunnen gevaar opleveren. Lees zorgvuldig de instructies alvorens met de montage te beginnen. Houd u tijdens de montage te allen tijde aan de instructies. Neem bij twijfel contact op met de dichtstbijzijnde Land Rover dealer.

### ΠΡΟΕΙΔΟΠΟΙΗΣΗ

Τα προαιρετικά εξαρτήματα που δεν έχουν τοποθετηθεί σωστά μπορεί να είναι επικίνδυνα. Διαβάστε τις οδηγίες πριν προχωρήσετε στην τοποθέτησή τους. Κατά την τοποθέτησή, τηρείτε συνεχώς τις οδηγίες. Αν έχετε οποιαδήποτε αμφιβολία, επικοινωνήστε με τον πλησιέστερο αντιπρόσωπο της.

### 注意

正しく取り付けられていない備品があると、事故の原因になります。取付ける前にこのマニュアルをよくお読みください。取付けの際は必ずこのマニュアルにある指示に従ってください。何か不明な点がありましたら、お近くのランド・ローバー社のディーラーまでお問い合わせください。



## FITTING INSTRUCTION

Auxiliary Wiring Kit

## EINBAUANLEITUNG

Hilfskabelbaum

## INSTRUCTION DE MONTAGE

Kit de câblage auxiliaire

## ISTRUZIONI PER L'USO

Corredo cablaggio ausiliare

## INSTRUCCIONES DE MONTAJE

Kit de cableado auxiliar

## INSTRUÇÕES DE MONTAGEM

Kit de Fiação Auxiliar

## MONTAGEHANDLEIDING

Aanvullende bedradingsset

## ΟΔΗΓΙΑ ΤΟΠΟΘΕΤΗΣΗΣ

Κιτ Βοηθητικής Καλωδίωσης

取付用マニュアル

補助ワイヤ キット

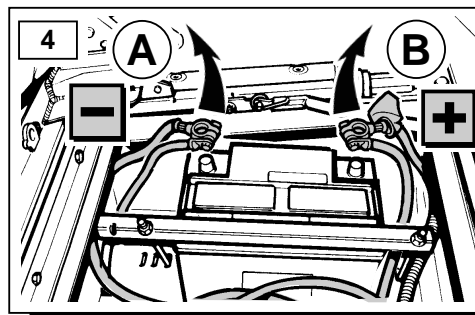
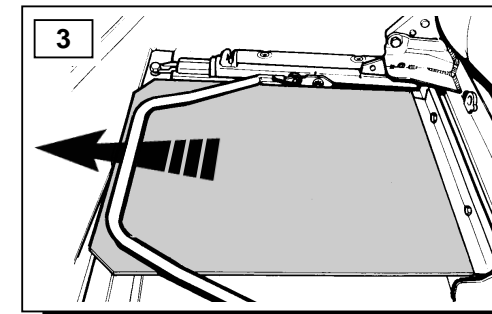
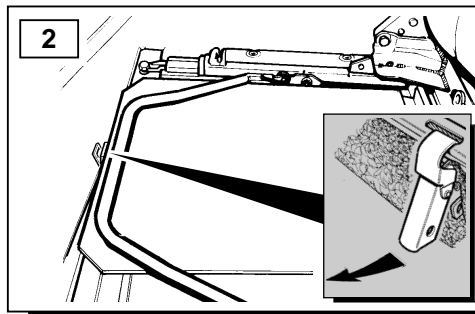
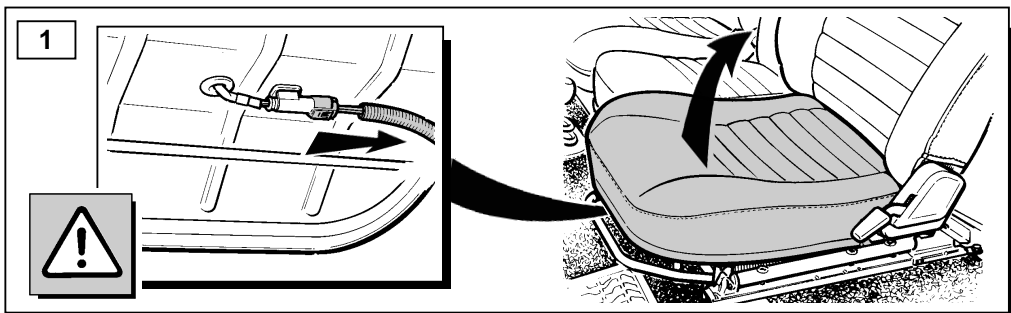
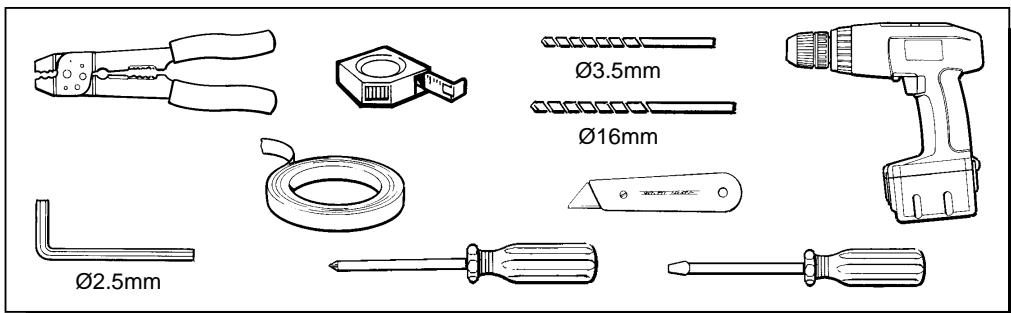
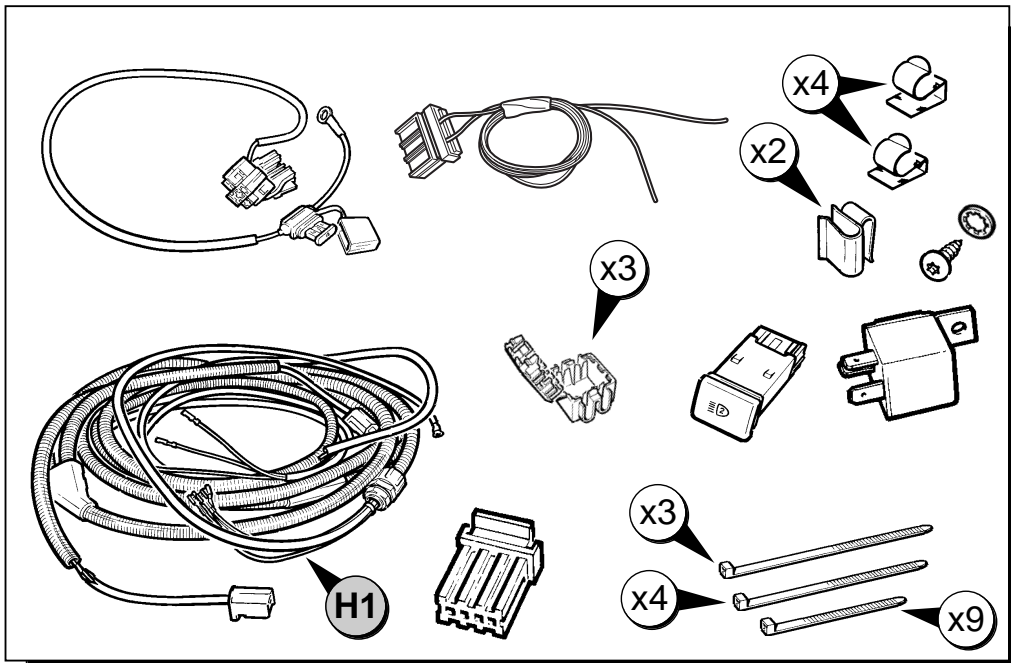

- GB For operation refer to handbook
- D Zur Benutzung siehe Handbuch.
- F Se reporter au manuel pour le fonctionnement
- I Per il funzionamento, fare riferimento al libretto d' istruzioni.
- E Consultar el Manual para el funcionamiento.
- P Consulte o manual para a operação.
- NL Raadpleeg het Handboek voor de werking.
- GR Για το χειρισμό ανατρέξτε στο εγχειρίδιο
- 日 使い方は取扱説明書を参照の事

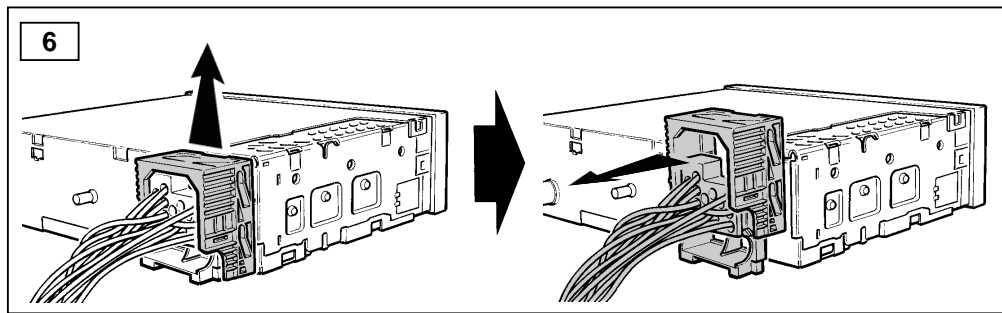
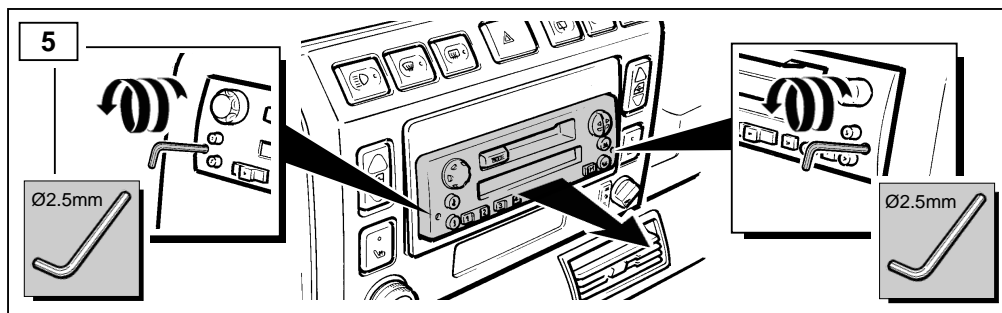
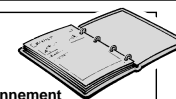

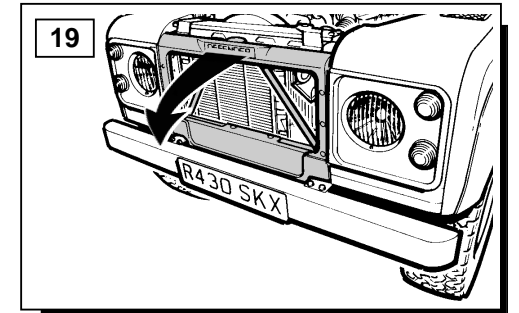
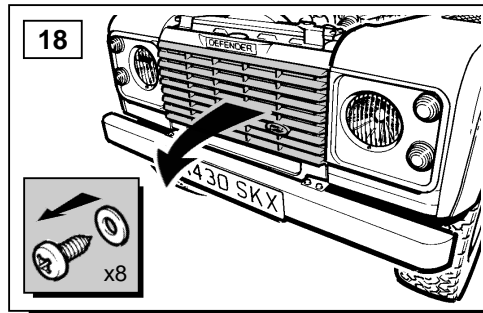
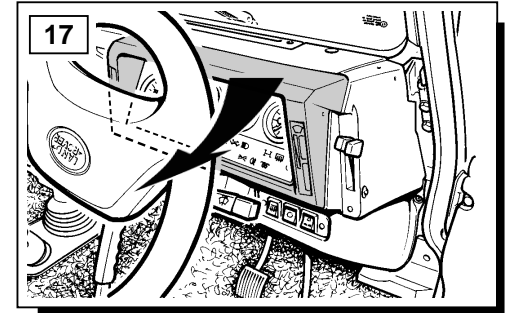
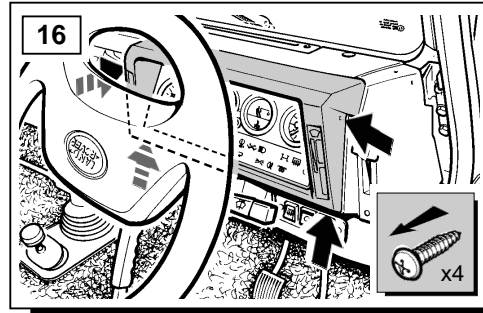
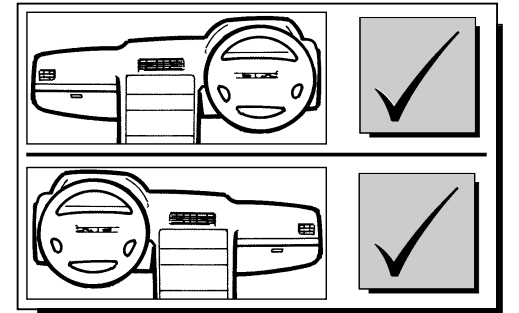
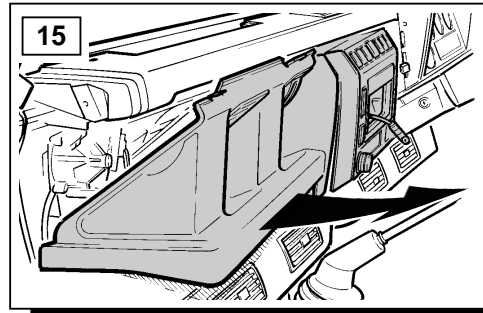
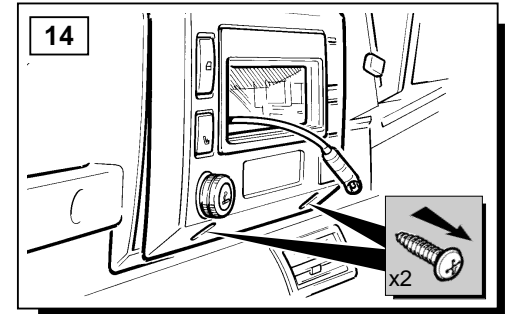
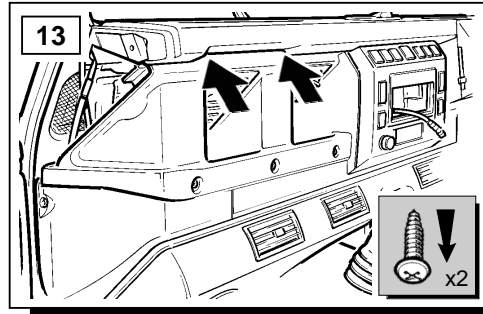
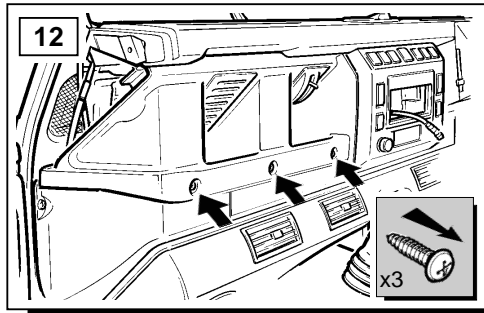
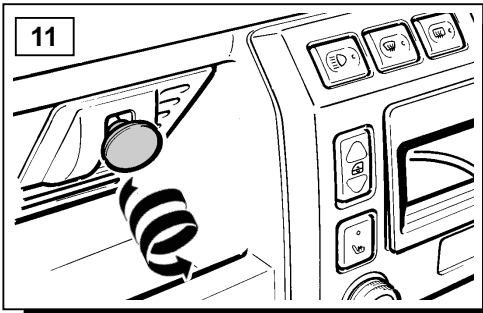
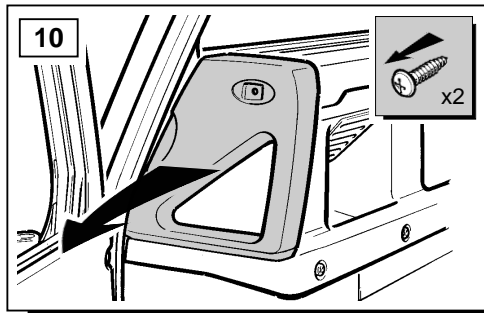
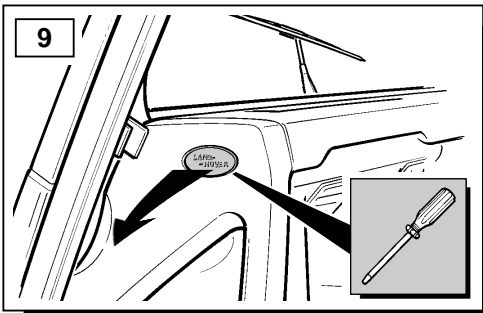
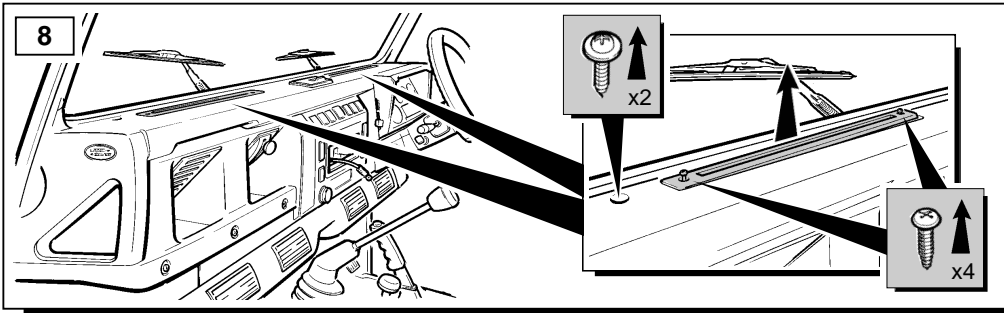
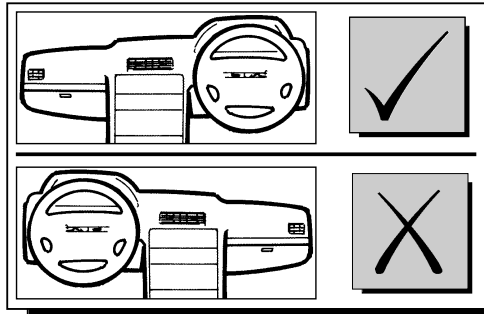
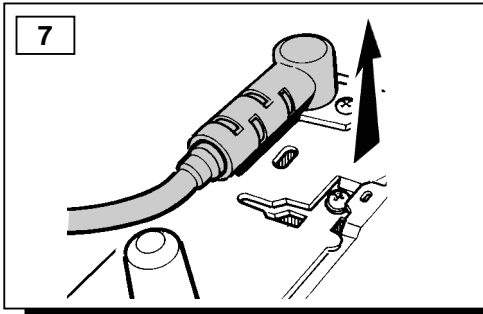

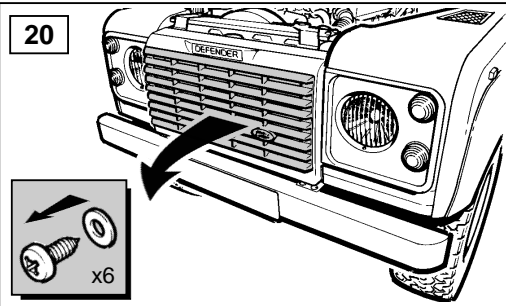

- (GB) Air Conditioning Only.
- (D) Nur für Klimaanlage.
- (F) Climatisation UNIQUEMENT.
- (I) Condizionamento aria SOLAMENTE.
- (E) Aire acondicionado SOLAMENTE.
- (P) APENAS Ar Condicionado.
- (NL) ALLEEN air-conditioning.
- (GR) ΜΟΝΟ για τον Κλιματισμό.
- (B) エアコンのみ

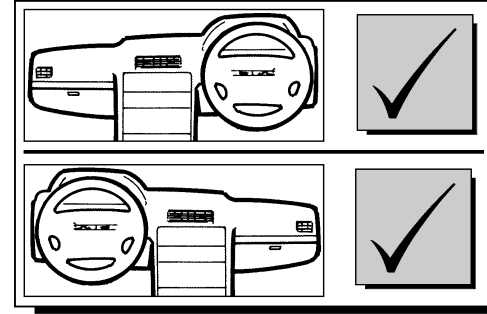
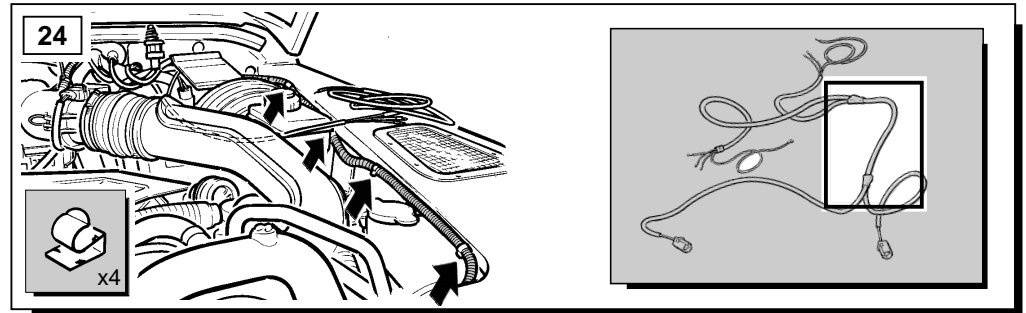
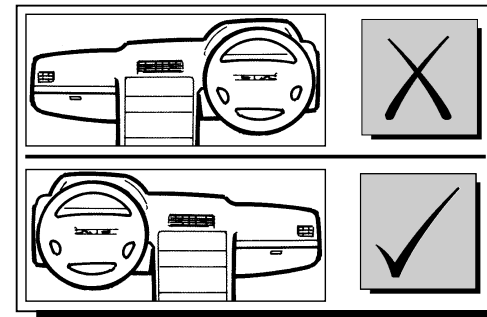
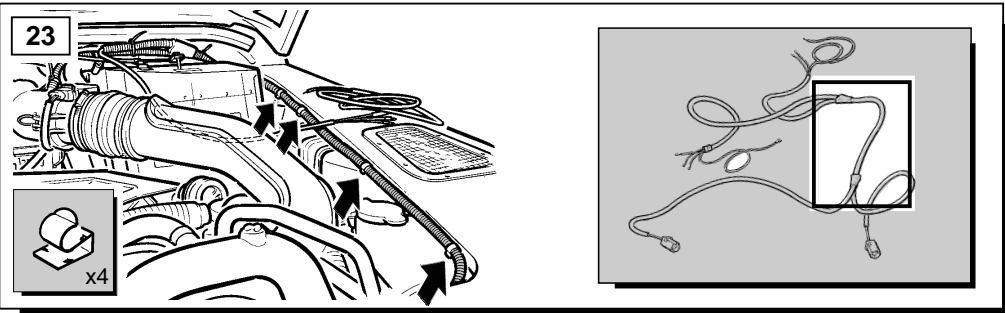
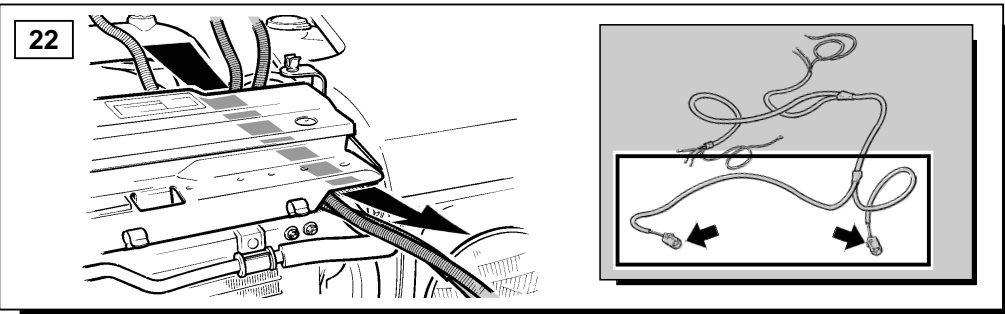
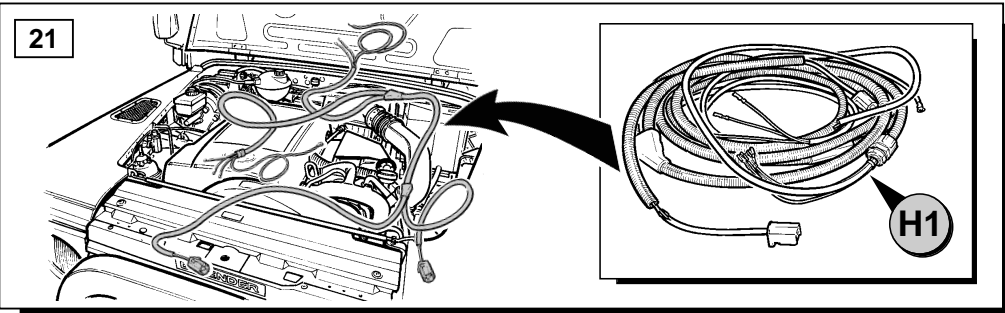





25

AC

- GB Air Conditioning Only.
- D Nur für Klimaanlage.
- F Climatisation UNIQUEMENT.
- I Condizionamento aria SOLAMENTE.
- E Aire acondicionado SOLAMENTE.
- P APENAS Ar Condicionado.
- NL ALLEEN air-conditioning.
- GR ΜΟΝΟ για τον Κλιματισμό.
- Ⓜ エアコンのみ

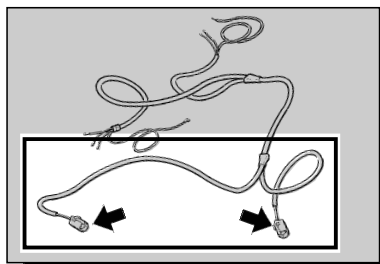
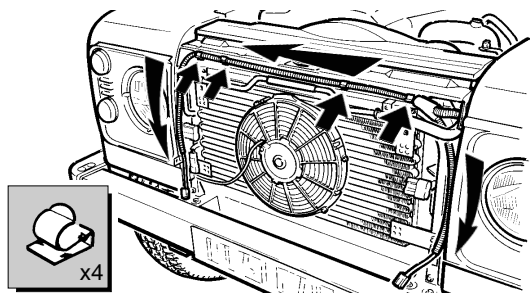

26

AC

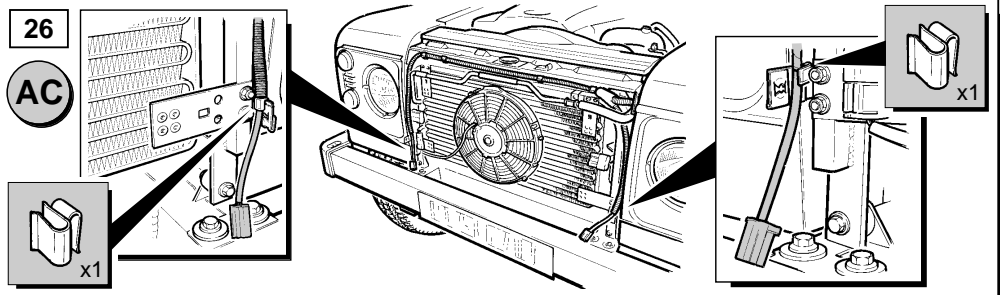

27

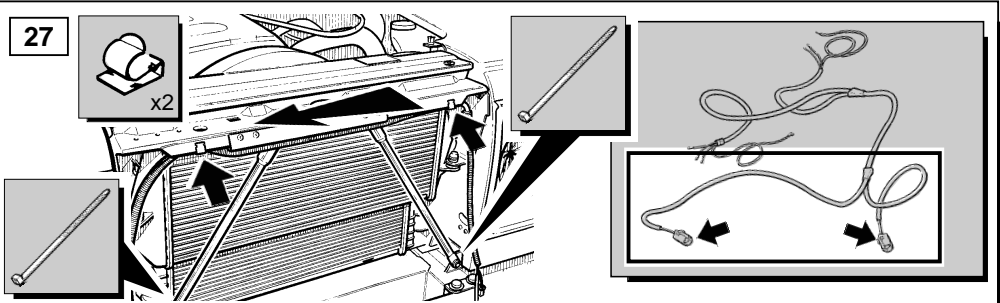

28

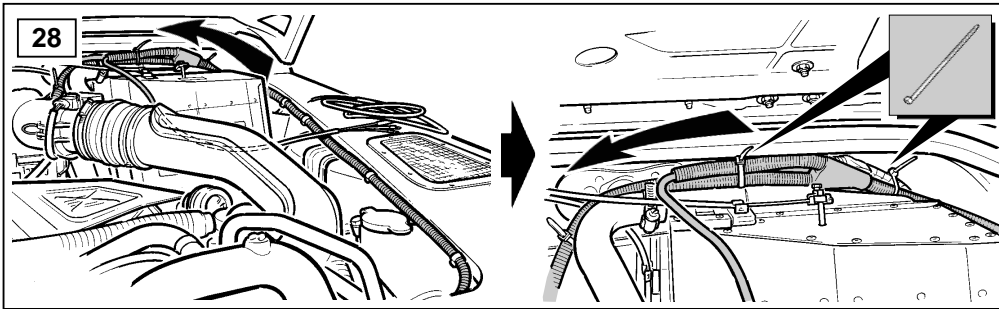

29

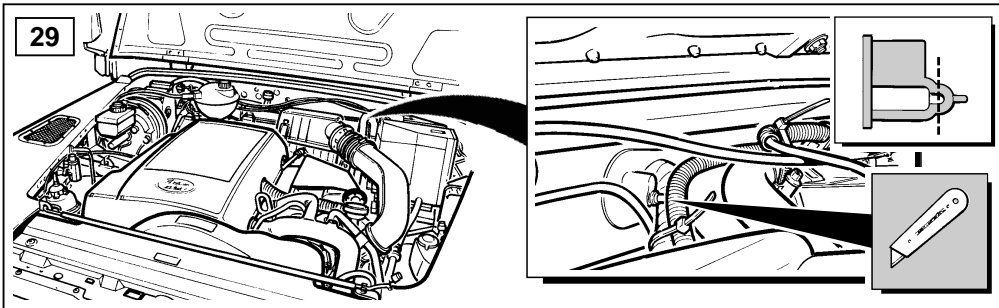

30

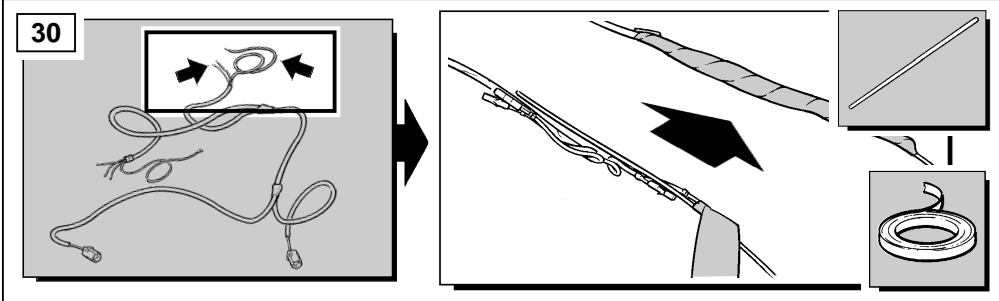

31

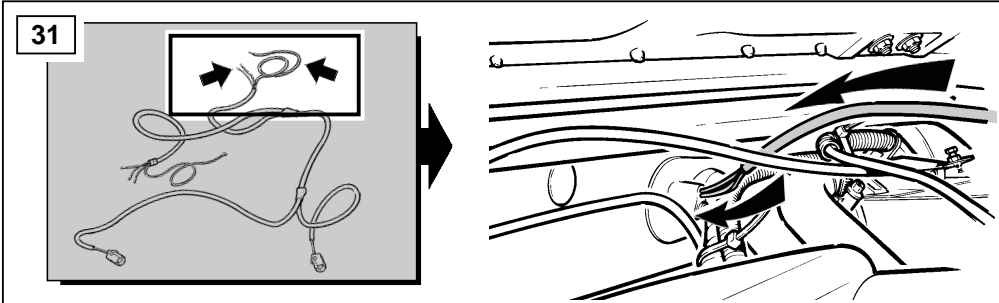

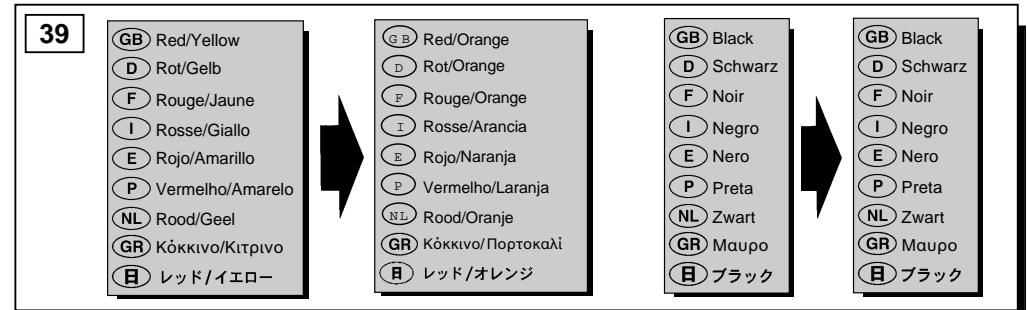
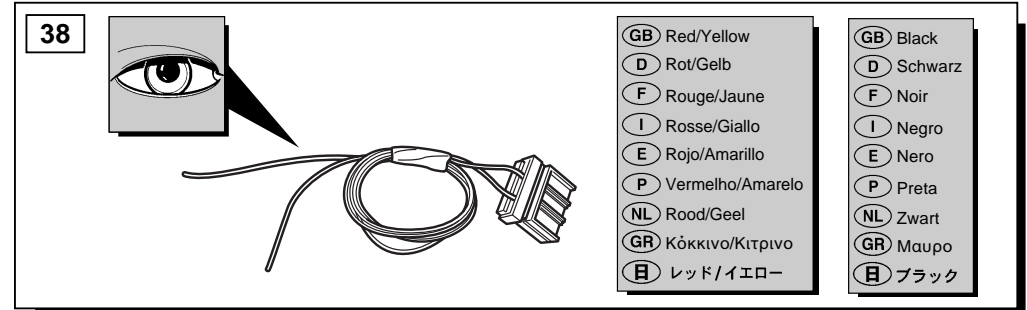
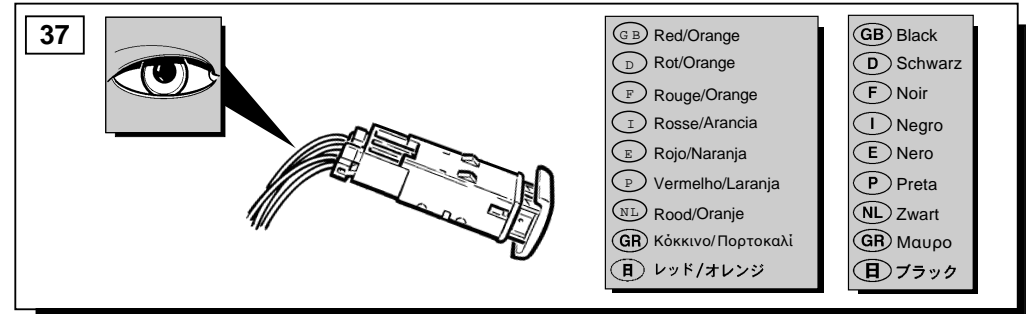
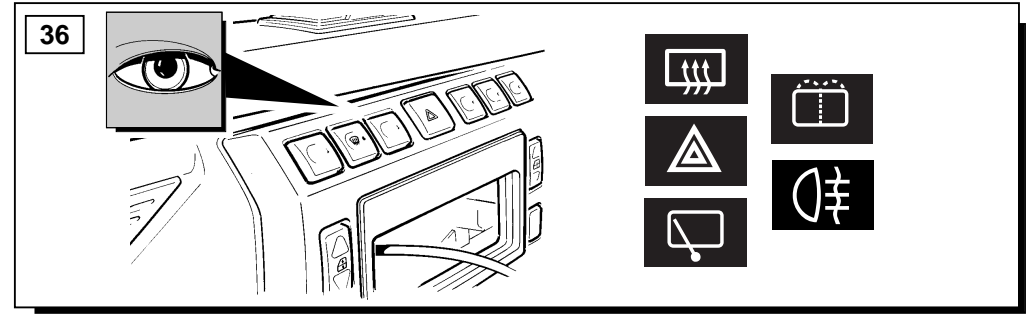
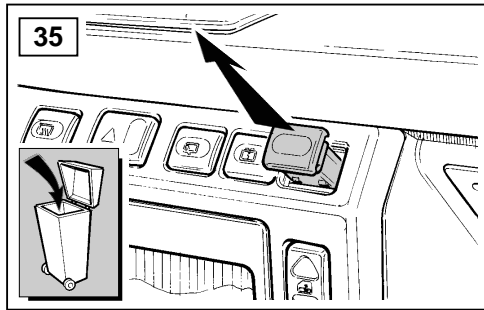
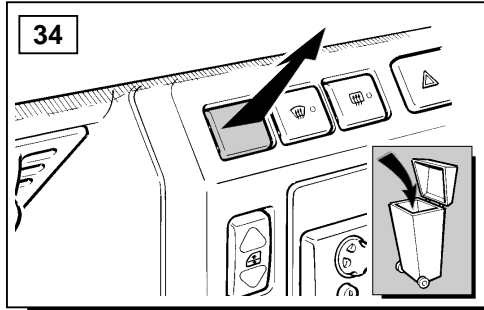
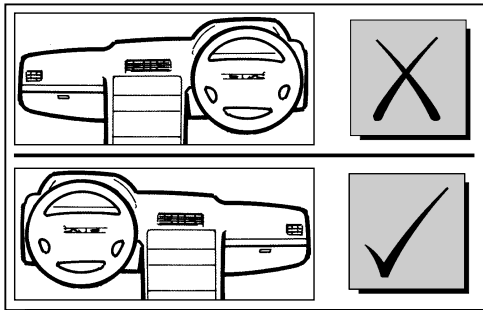
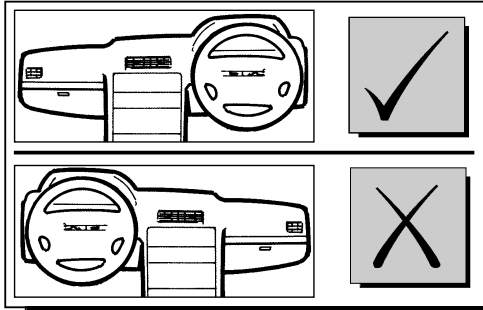
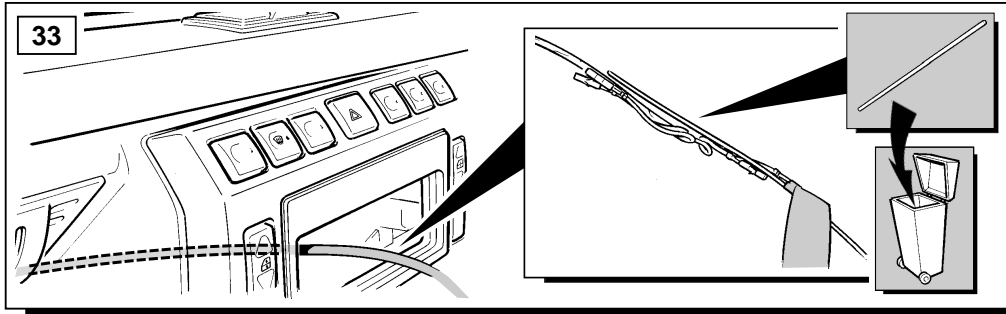
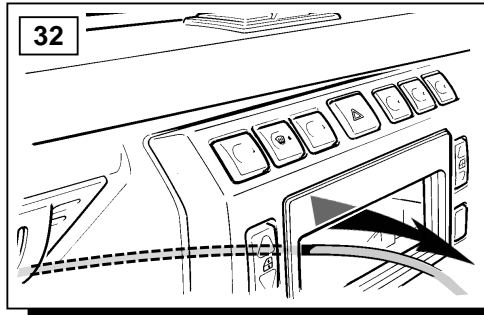

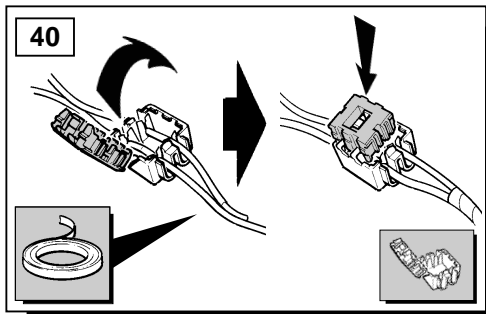

41

①	⑤
<ul style="list-style-type: none"> <li>GB Blue</li> <li>D Blau</li> <li>F Bleu</li> <li>I Azzuro</li> <li>E Azul</li> <li>P Azul</li> <li>NL Blauw</li> <li>GR Μπλε</li> <li>B ブルー</li> </ul>	<ul style="list-style-type: none"> <li>Blue/yellow</li> <li>Blau/Gelb</li> <li>Bleu/Jaune</li> <li>Azzuro/Jaune</li> <li>Azul/Amarillo</li> <li>Azul/Amarelo</li> <li>Blauw/Geel</li> <li>Μπλε/Κίτρινο</li> <li>ブルー/イエロー</li> </ul>

1 2 3 4 5

- GB Black
- D Schwarz
- F Noir
- I Negro
- E Nero
- P Preta
- NL Zwart
- GR Μαυρο
- B ブラック

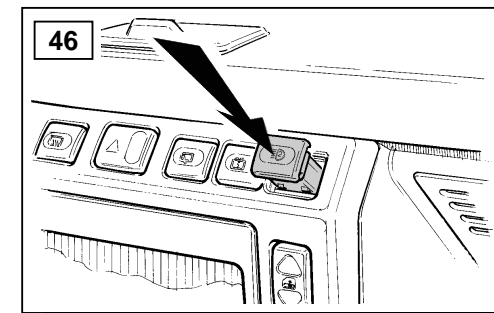
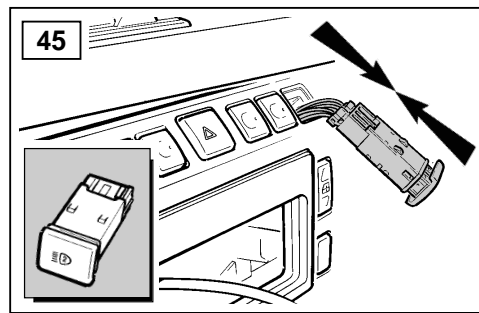
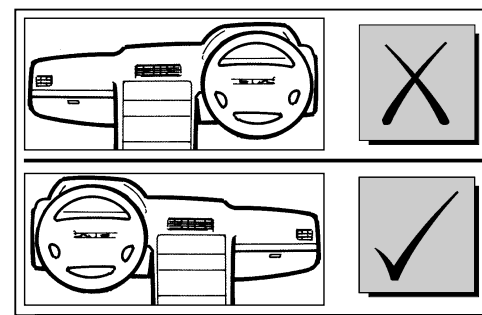
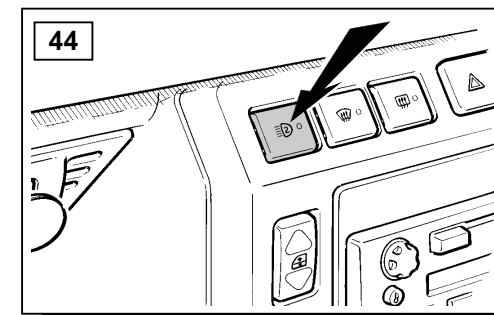
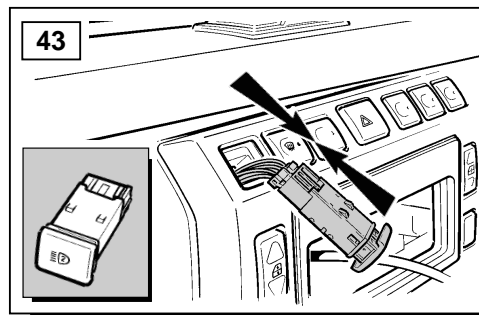
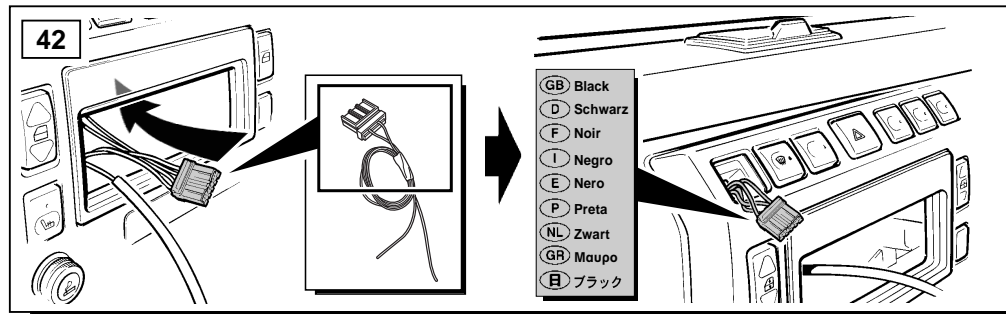
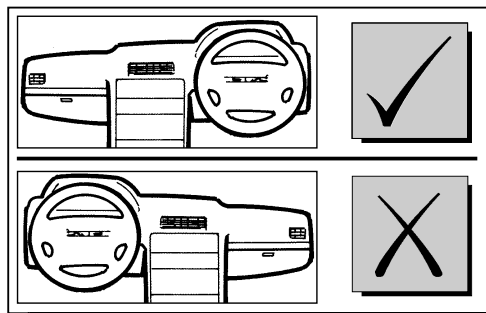

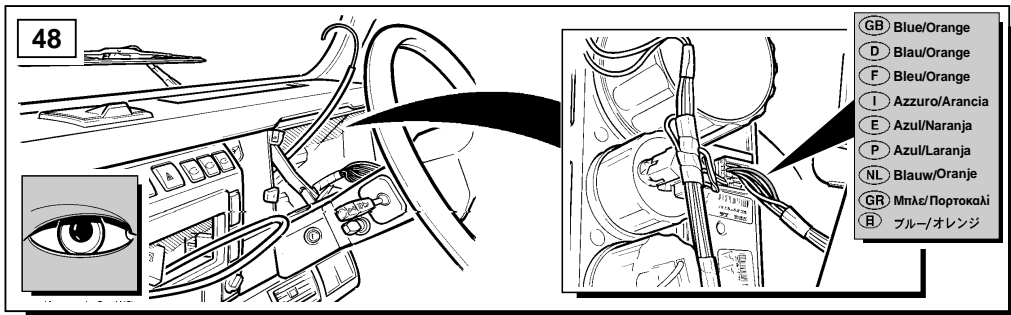
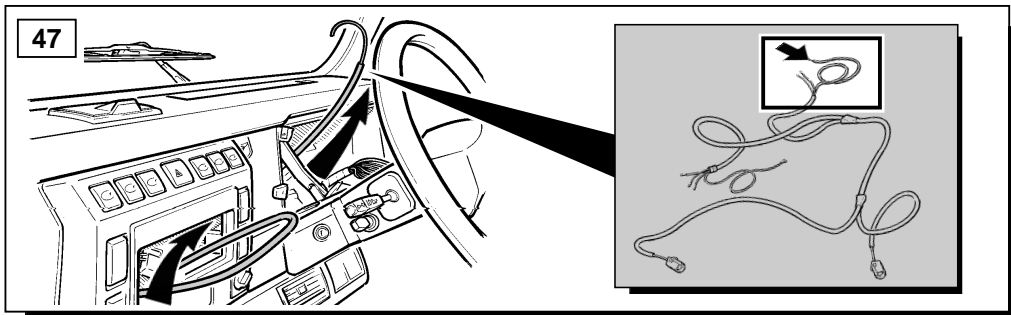
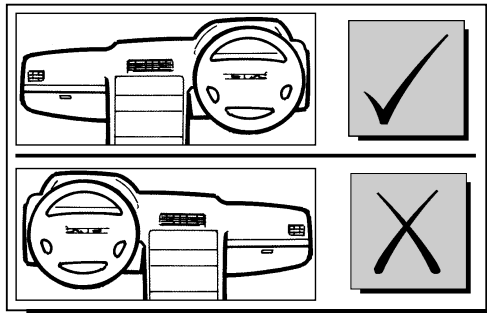

- GB Blue/Orange
- D Blau/Orange
- F Bleu/Orange
- I Azzuro/Arancia
- E Azul/Naranja
- P Azul/Laranja
- NL Blauw/Oranje
- GR Μπλε/ Πορτοκαλί
- R ブルー/オレンジ

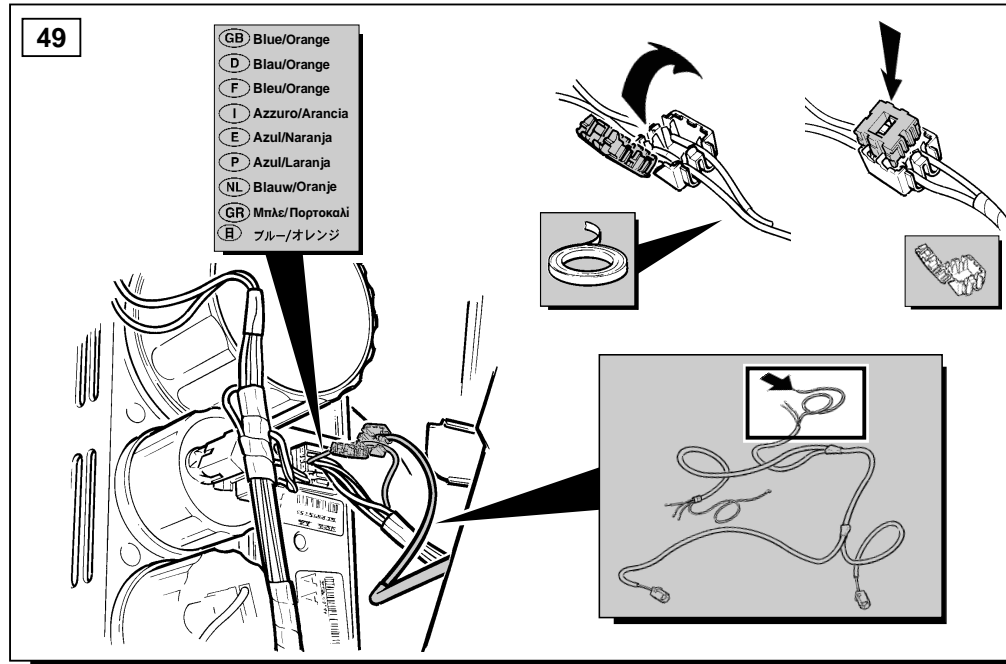

- GB Blue/Orange
- D Blau/Orange
- F Bleu/Orange
- I Azzuro/Arancia
- E Azul/Naranja
- P Azul/Laranja
- NL Blauw/Oranje
- GR Μπλε/ Πορτοκαλί
- R ブルー/オレンジ

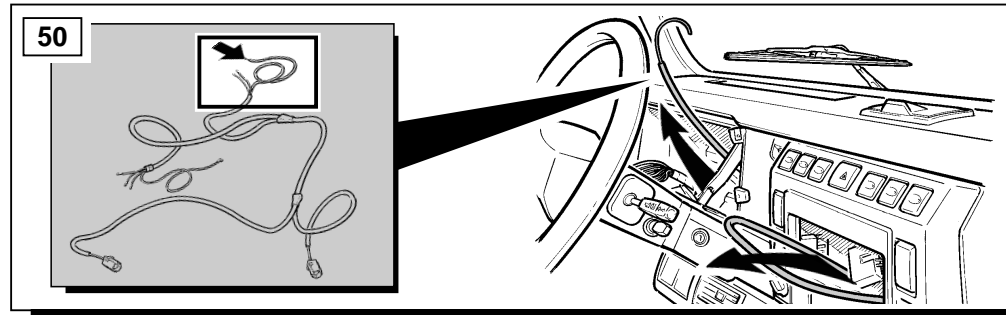
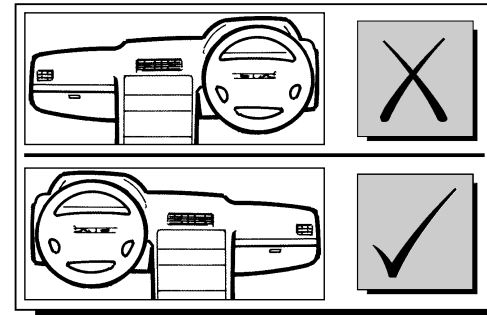



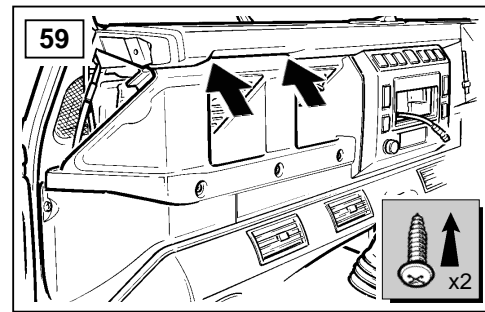
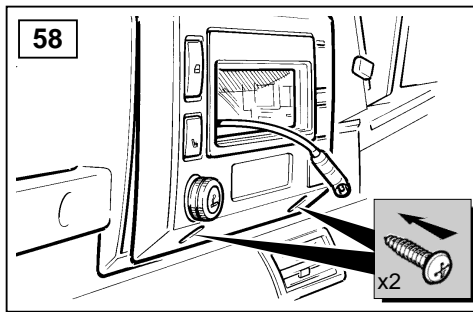
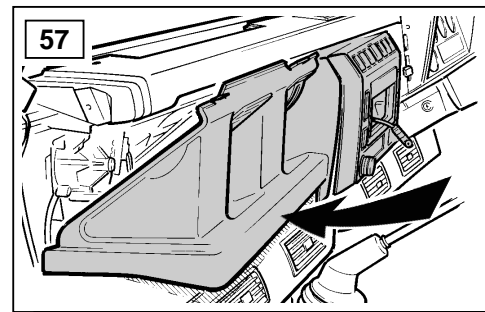
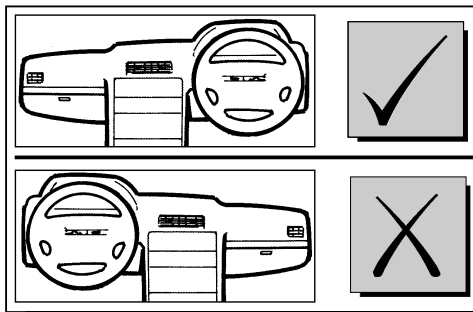
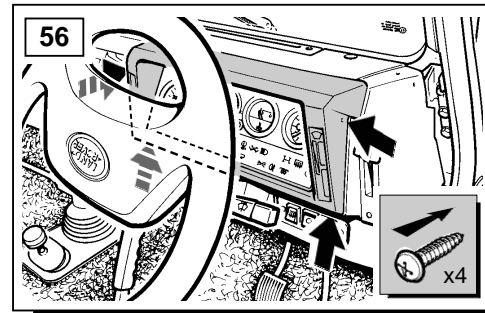
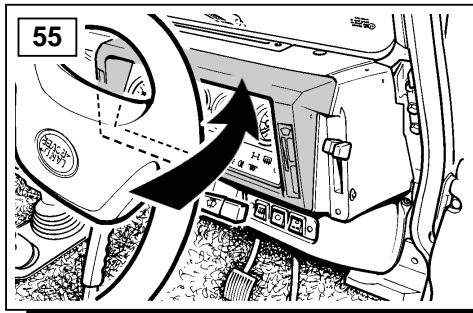
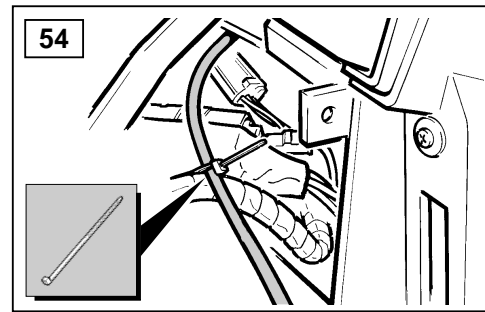
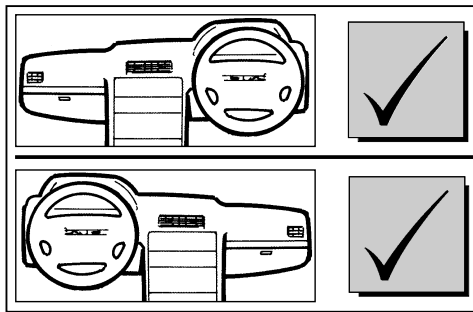
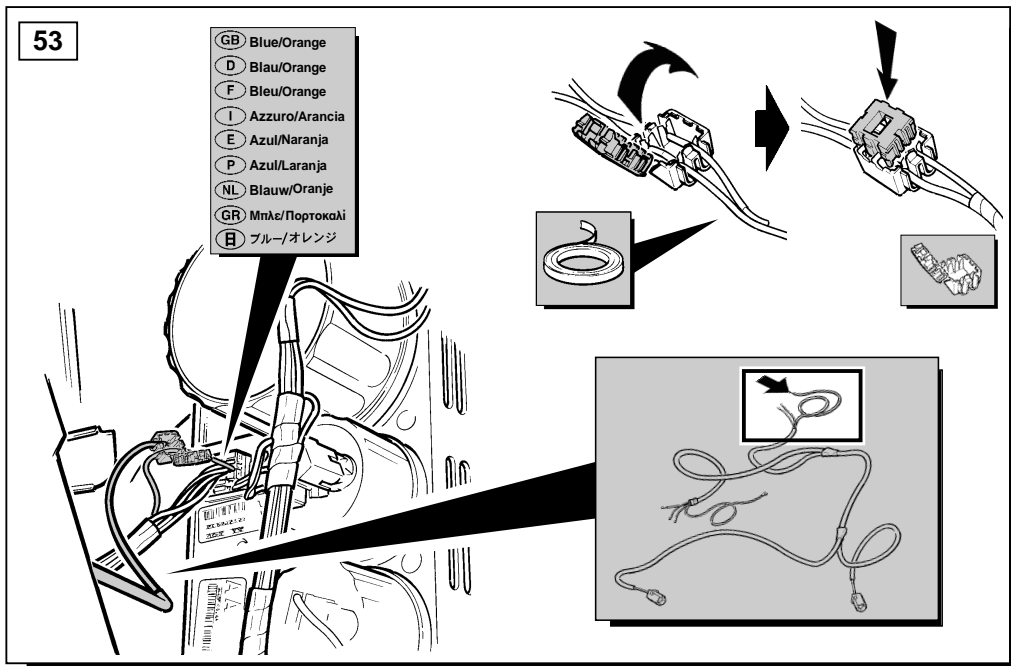
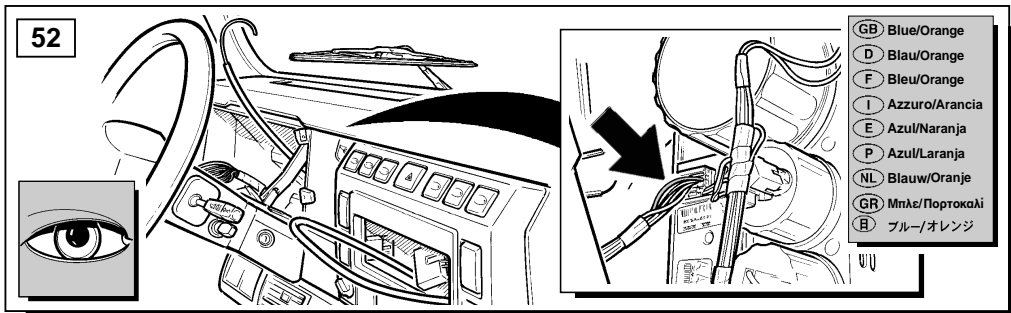
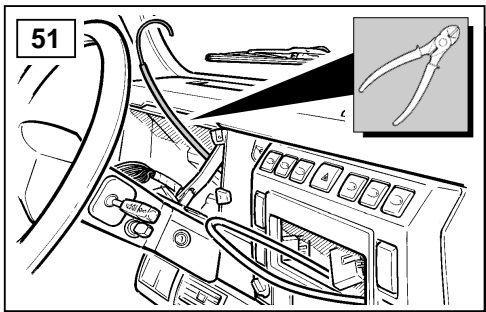

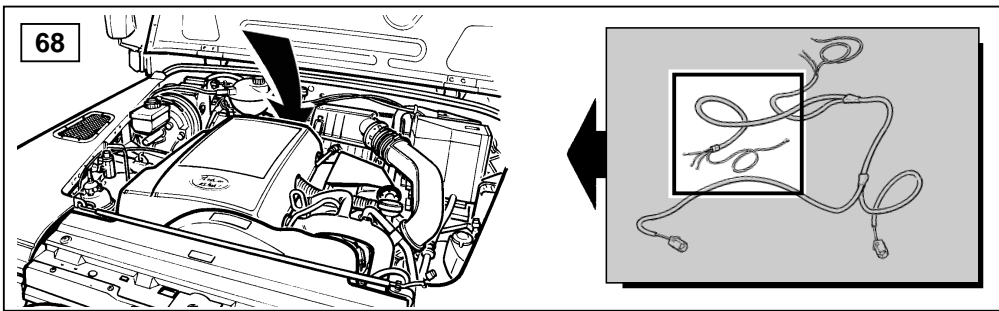
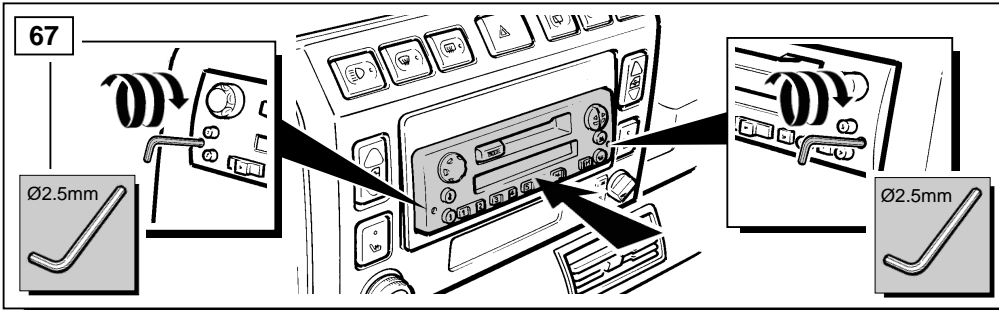
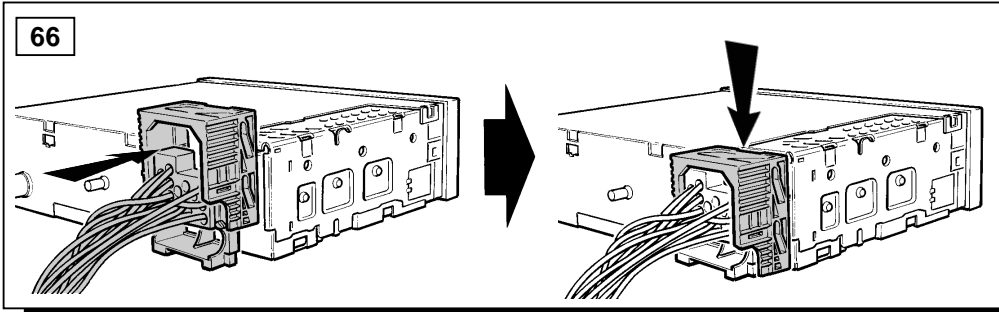
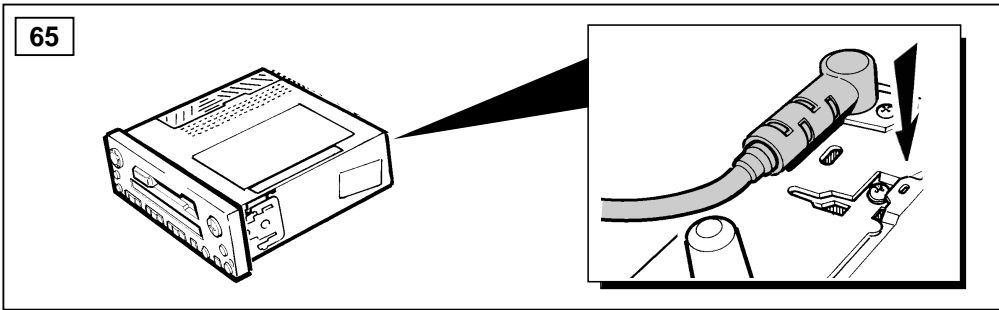
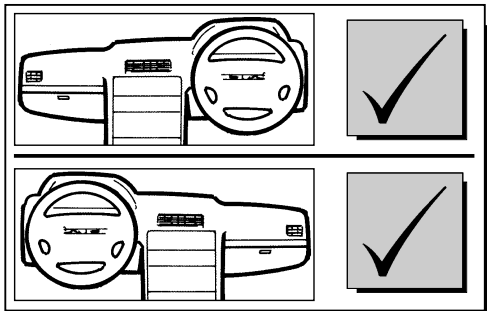
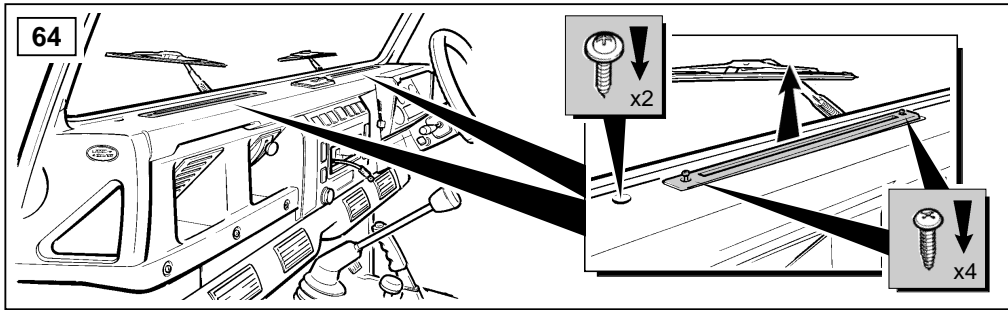
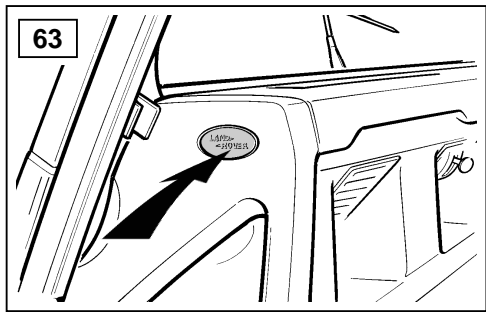
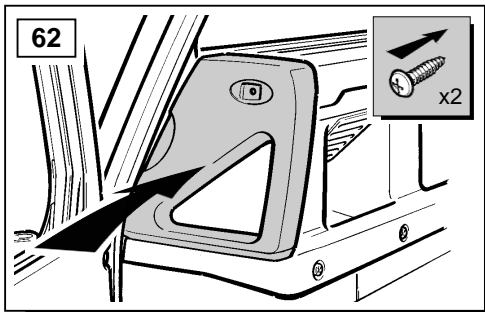
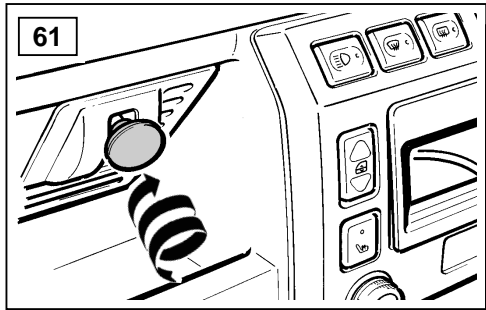
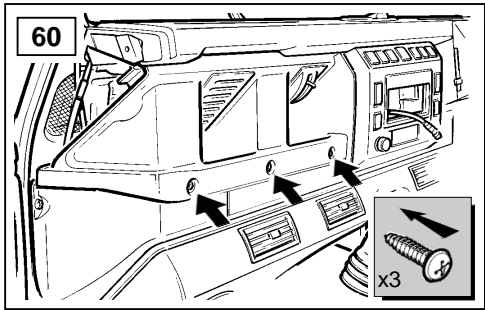

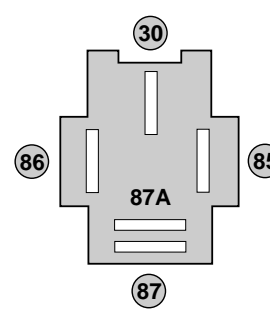
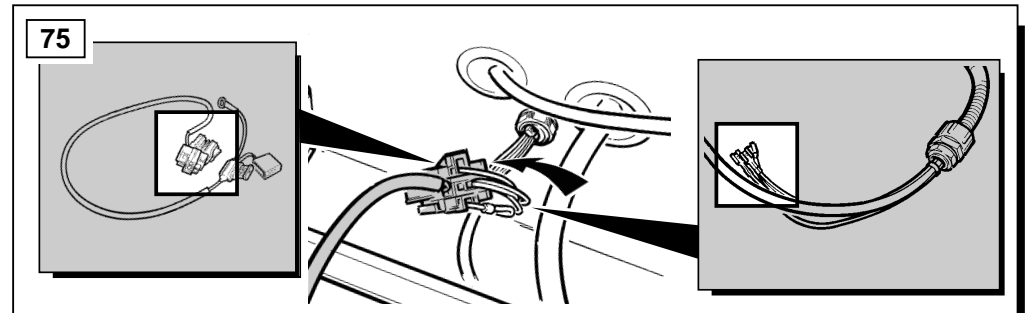
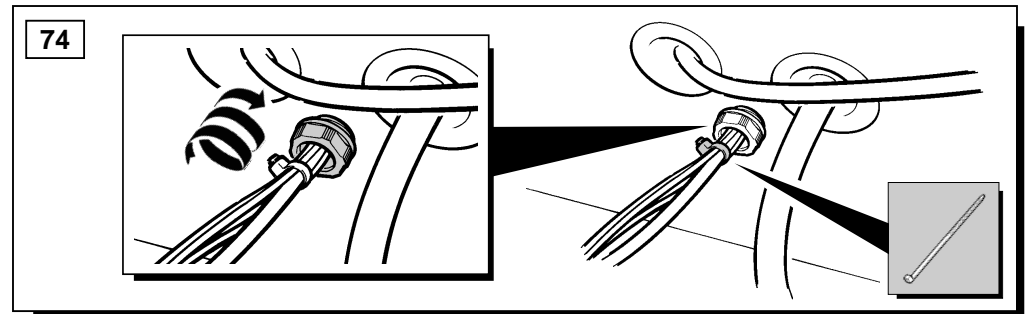
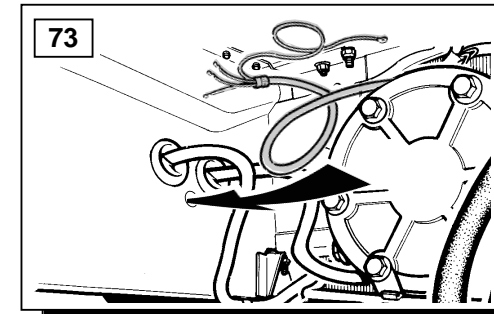
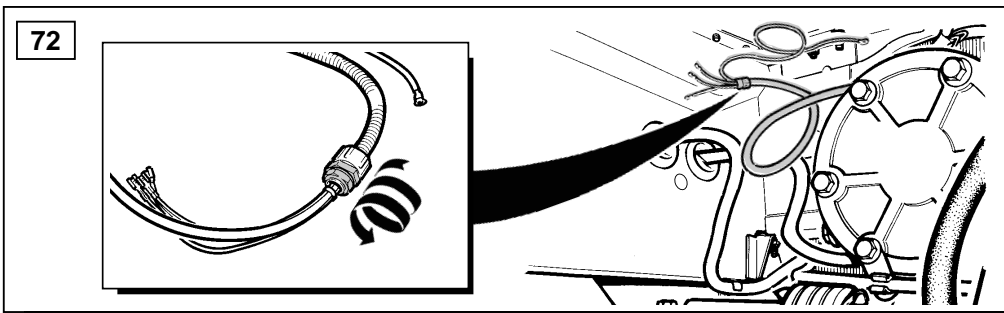
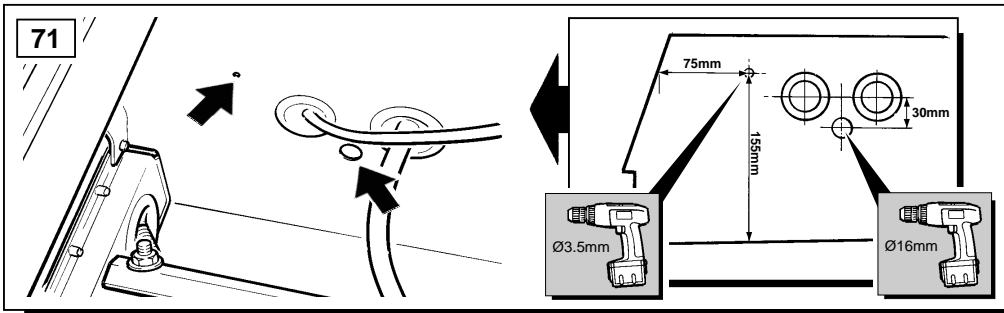
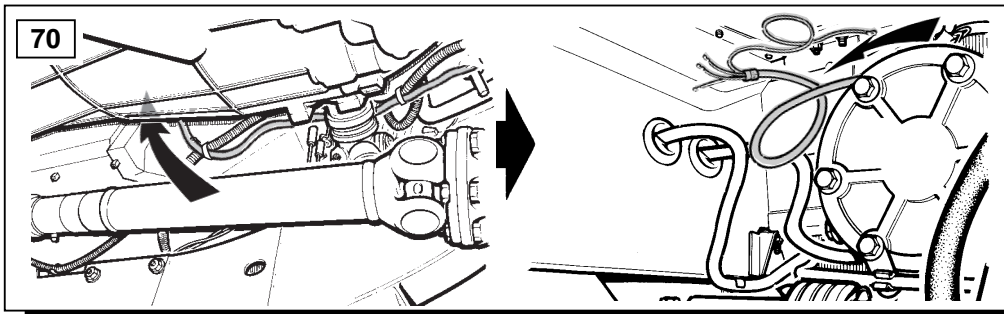
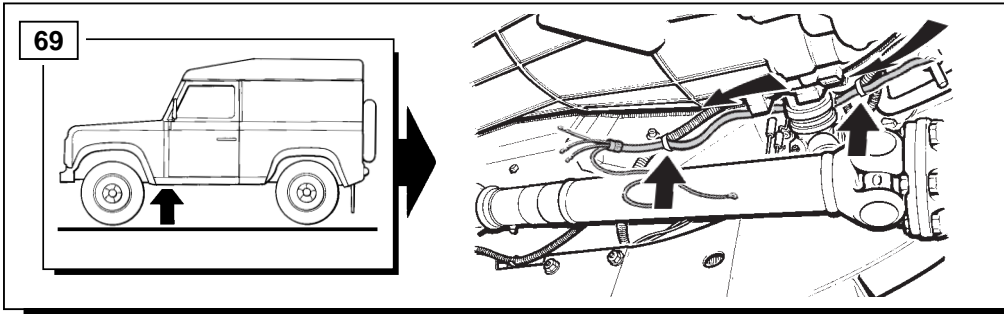



	30	86	85	87
GB	Red	Blue	Blue/Orange	Blue/yellow
D	Rot	Blau	Blau/Orange	Blau/Gelb
F	Rouge	Bleu	Blanc/Orange	Bleu/Jaune
I	Rosse	Azzuro	Azzuro/Arancia	Azzuro/Jaune
E	Rojo	Azul	Azul/Naranja	Azul/Amarillo
P	Vermelho	Azul	Azul/Laranja	Azul/Amarelo
NL	Rood	Blauw	Blauw/Oranje	Blauw/Geel
GR	Κόκκινο	Μπλε	Μπλε/Πορτοκαλί	Μπλε/Κίτρινο
R	レッド	ブルー	ブルー / オレンジ	ブルー / イエロー

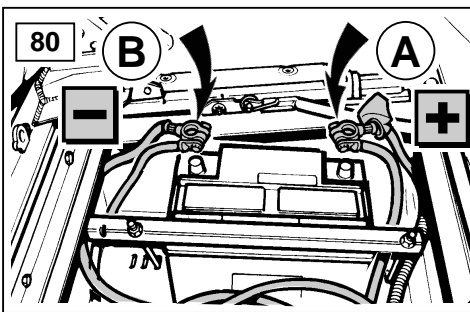
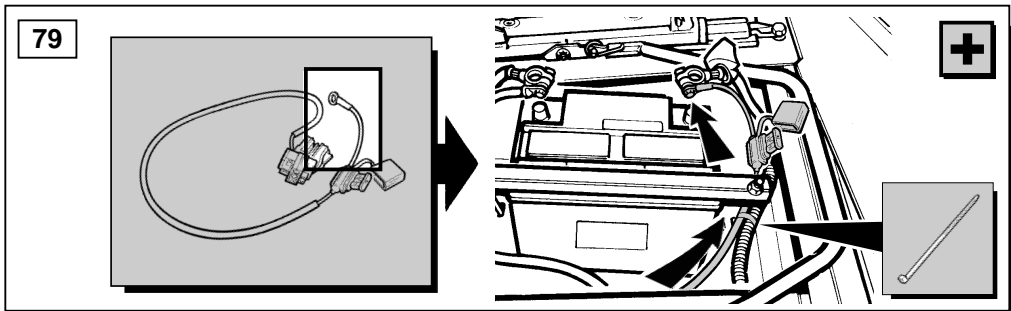
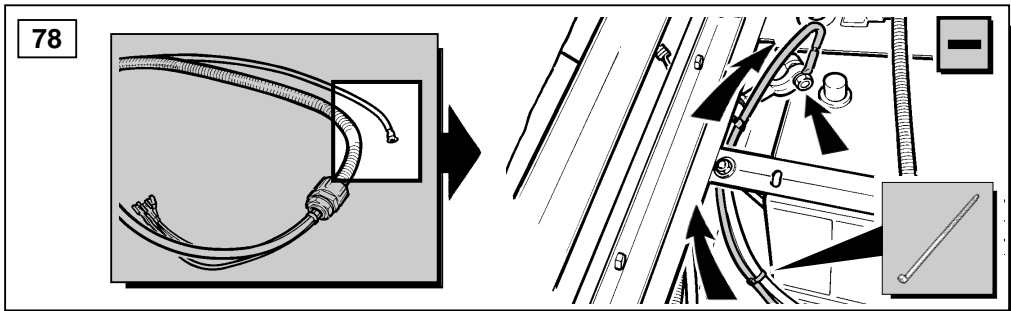
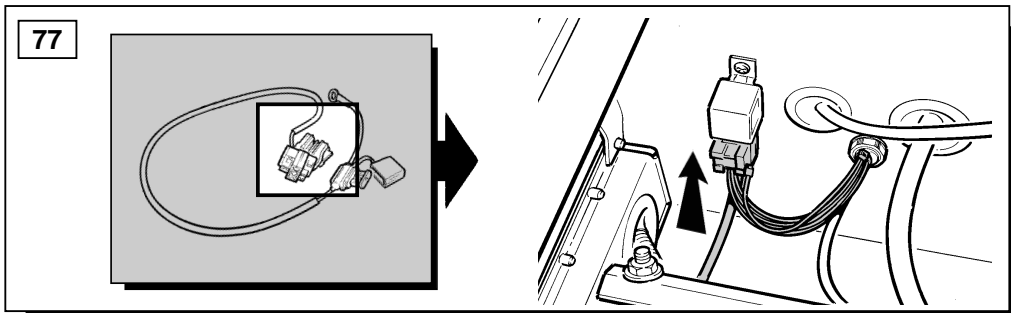
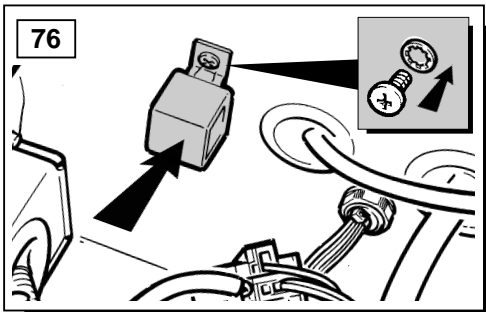

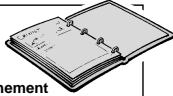

**GB** For operation refer to handbook  
**D** Zur Benutzung siehe Handbuch.  
**F** Se reporter au manuel pour le fonctionnement  
**I** Per il funzionamento, fare riferimento al libretto d' istruzioni.  
**E** Consultar el Manual para el funcionamiento.  
**P** Consulte o manual para a operação.  
**NL** Raadpleeg het Handboek voor de werking.  
**GR** Για το χειρισμό ανατρέξτε στο εγχειρίδιο  
**日** 使い方は取扱説明書を参照の事

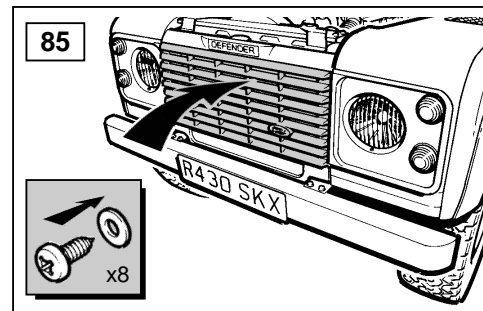
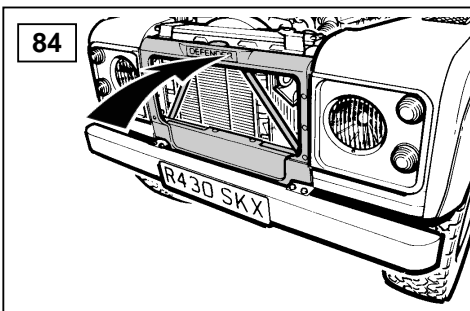
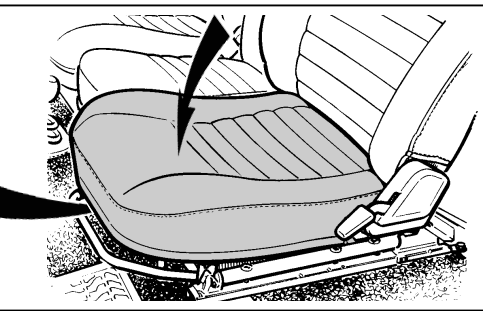
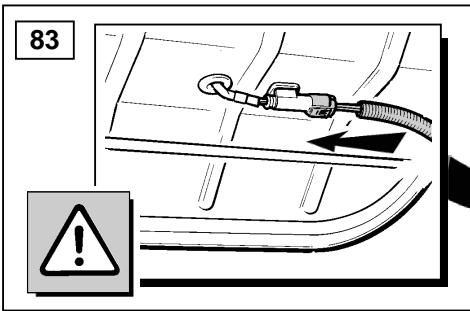
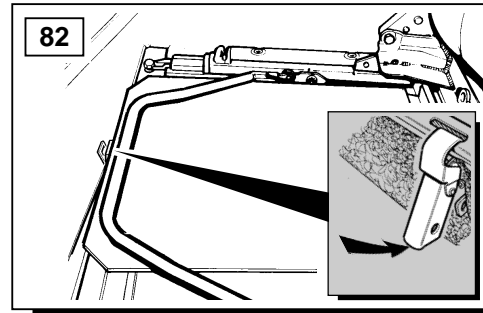
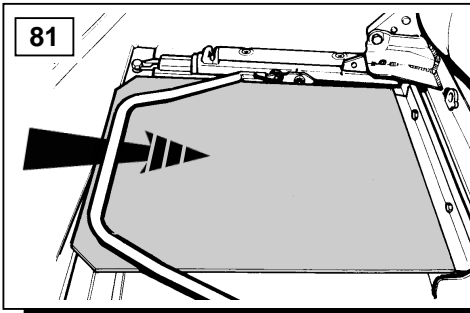

86

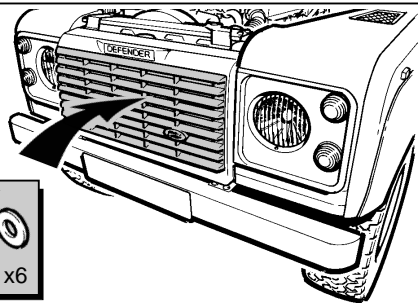

- (GB) Air Conditioning Only.
- (D) Nur für Klimaanlage.
- (F) Climatisation UNIQUEMENT.
- (I) Condizionamento aria SOLAMENTE.
- (E) Aire acondicionado SOLAMENTE.
- (P) APENAS Ar Condicionado.
- (NL) ALLEEN air-conditioning.
- (GR) MONO για τον Κλιματισμό.
- (H) エアコンのみ